

# ***460MMSC-N2EW*** ***Protocol Gateway***

## **Product User Guide**

---

*Firmware Version 8.9.39*

## Trademarks

CompactLogix, ControlLogix, & PLC-5 are registered trademarks of Rockwell Automation, Inc. EtherNet/IP is a trademark of the ODVA. MicroLogix, RSLogix 500, and SLC are trademarks of Rockwell Automation, Inc. Microsoft, Windows, and Internet Explorer are registered trademarks of Microsoft Corporation. BACnet® is a registered trademark of American Society of Heating, Refrigerating and Air-Conditioning Engineers (ASHRAE). All other trademarks and registered trademarks are the property of their holders.

## Limited Warranty

Real Time Automation, Inc. warrants that this product is free from defects and functions properly.

EXCEPT AS SPECIFICALLY SET FORTH ABOVE, REAL TIME AUTOMATION, INC. DISCLAIMS ALL OTHER WARRANTIES, BOTH EXPRESSED AND IMPLIED, INCLUDING BUT NOT LIMITED TO IMPLIED WARRANTIES OF MERCHANTABILITY OR FITNESS FOR A PARTICULAR APPLICATION. THIS LIMITED WARRANTY GIVES YOU SPECIFIC LEGAL RIGHTS. YOU MAY ALSO HAVE OTHER RIGHTS, WHICH VARY FROM STATE TO STATE.

The examples and diagrams in this manual are included solely for illustrative purposes. Because of the many variables and requirements associated with any particular application, Real Time Automation, Inc. cannot assume responsibility or liability for actual use based on the examples and diagrams. Except as specifically set forth above, Real Time Automation and its distributors and dealers will in no event be liable for any damages whatsoever, either direct or indirect, including but not limited to loss of business profits, income, or use of data. Some states do not allow exclusion or limitation of incidental or consequential damages; therefore, the limitations set forth in this agreement may not apply to you.

No patent liability is assumed by Real Time Automation with respect to use of information, circuits, equipment, or software described in this manual.

## Government End-Users

If this software is acquired by or on behalf of a unit or agency of the United States Government, this provision applies: The software (a) was developed at private expense, is existing computer software, and was not developed with government funds; (b) is a trade secret of Real Time Automation, Inc. for all purposes of the Freedom of Information Act; (c) is "restricted computer software" submitted with restricted rights in accordance with subparagraphs (a) through (d) of the Commercial "Computer Software-Restricted Rights" clause at 52.227-19 and its successors; (d) in all respects is proprietary data belonging solely to Real Time Automation, Inc.; (e) is unpublished and all rights are reserved under copyright laws of the United States. For units of the Department of Defense (DoD), this software is licensed only with "Restricted Rights": as that term is defined in the DoD Supplement of the Federal Acquisition Regulation 52.227-7013 (c) (1) (ii), rights in Technical Data and Computer Software and its successors, and: Use, duplication, or disclosures is subject to restrictions as set forth in subdivision (c) (1) (ii) of the Rights in Technical Data and Computer Software clause at 52.227-7013. If this software was acquired under GSA schedule, the U.S. Government has agreed to refrain from changing or removing any insignia or lettering from the Software or documentation that is provided or from producing copies of the manual or media. Real Time Automation, Inc.

© 2024 Real Time Automation, Inc. All rights reserved.

|  |    |
|--|----|
| Revision History .....                             | 5  |
| Overview .....                                     | 7  |
| Hardware Platforms.....                            | 8  |
| Hardware – N2EW.....                               | 9  |
| <b>Powering the Gateway</b> .....                  | 9  |
| Port Configuration.....                            | 11 |
| RS232 pinouts: .....                               | 11 |
| RS485 pinouts: .....                               | 11 |
| RS422 pinouts: .....                               | 12 |
| TTL pinouts:.....                                  | 12 |
| Mounting with a DIN Rail.....                      | 13 |
| Installing.....                                    | 13 |
| Removing .....                                     | 13 |
| Accessing the Main Page.....                       | 14 |
| Committing Changes to the Settings .....           | 16 |
| Main Page .....                                    | 17 |
| Device Configuration.....                          | 18 |
| Network Configuration .....                        | 19 |
| Modbus RTU Client Configuration .....              | 21 |
| Modbus RTU Client Device Configuration .....       | 22 |
| Configuring Read and Write Scan Lines .....        | 24 |
| S7 Client Configuration .....                      | 26 |
| External Server Configuration.....                 | 27 |
| Configuring Read and Write Scan Lines .....        | 28 |
| Mapping - Transferring Data Between Devices .....  | 32 |
| Display Mapping and Values .....                   | 33 |
| Display Data .....                                 | 33 |
| Display String.....                                | 36 |
| Display String use case .....                      | 38 |
| Data and String Mapping – Auto-Configure.....      | 39 |
| Data Mapping – Explanation.....                    | 40 |
| Data Mapping – Adding Diagnostic Information ..... | 41 |

|  |           |
|--|-----------|
| String Mapping – Explanation .....                           | 46        |
| Mapping – Auto-Configure Mode to Manual Configure Mode ..... | 47        |
| Mapping – Manual Configure Mode to Auto-Configure Mode ..... | 48        |
| View as Text .....   | 49        |
| Data Mapping.....  | 49        |
| String Mapping.....  | 49        |
| Base Triggering – Data Validation Triggering.....            | 50        |
| Security Configuration .....                                 | 52        |
| Security Configuration-Security Levels .....                 | 53        |
| Security - Log In.....                                       | 54        |
| Security - Log Out.....                                      | 54        |
| Email Configuration .....                                    | 55        |
| Alarm Configuration.....                                     | 56        |
| Diagnostics – Alarm Status.....                              | 58        |
| Alarms – Active .....  | 58        |
| Alarms – Clear .....   | 59        |
| Change of State (COS) Configuration.....                     | 60        |
| Diagnostics Info.....  | 61        |
| Diagnostics Mapping.....                                     | 61        |
| <b>Diagnostics – Modbus RTU Client .....</b>                 | <b>62</b> |
| Diagnostics – S7 Client .....                                | 67        |
| LED Configuration .....                                      | 70        |
| Configuration Files .....                                    | 71        |
| Export Configuration.....                                    | 71        |
| Import Configuration .....                                   | 71        |
| Save and Replace Configuration Using SD Card.....            | 73        |
| Saving Configuration Using SD Card.....                      | 73        |
| Replacing Configuration Using SD Card .....                  | 73        |
| Intelligent Reset Button .....                               | 74        |
| Utilities .....  | 75        |

## Revision History

| Version       | Date       | Notes   |
|---------------|------------|---|
| <b>8.4.5</b>  | 11/18/2019 | <p>Features Added</p> <ol style="list-style-type: none"> <li>Released OPC UA Server (US) Protocol</li> <li>Ability to now Import/Export Template Files with out an FTP session</li> </ol> <p>Bug Fixes</p> <ol style="list-style-type: none"> <li>Updated Profinet Server (PS) on N34 hardware Platform</li> <li>Updated Wi-Fi software</li> </ol>  |
| <b>8.6.0</b>  | 2/28/20    | <p>Bug Fixes</p> <ol style="list-style-type: none"> <li>Omron Plc Communication fixes for EtherNet/IP</li> <li>Profinet GSDML Substitute values fix</li> </ol>  |
| <b>8.7.4</b>  | 9/1/20     | <p>Features Added:</p> <ol style="list-style-type: none"> <li>BMS, BM, DFM, DS, DM, TCP, USB, PBS have been ported to the latest base software</li> <li>TCP,BMS,BM now Available on N2E and N2EW hardware Platform</li> <li>New ASCII Mode Available on TCP/A/USB/WI protocols</li> <li>User Guides updated with more examples</li> </ol> <p>Bug Fixes:</p> <ol style="list-style-type: none"> <li>Improved Data Mapping and String Mapping performance</li> <li>Improved functionality/performance on EC,ETC,ES,MC,MS,BS,BC, A,,WI,PS protocols</li> </ol> |
| <b>8.7.22</b> | 4/6/21     | <p>Features Added:</p> <ol style="list-style-type: none"> <li>Support for RSLogix Versions 32 + with unsigned data type support</li> <li>ETC now support Long integer files (L files) for MicroLogix PLCS that support them</li> <li>SC now supports data block (DB) access</li> </ol>  |
| <b>8.7.53</b> | 4/28/21    | <p>Features Added:</p> <ol style="list-style-type: none"> <li>Added support for the NNBU hardware platform</li> <li>Improved RFIDEas scanner support</li> <li>Updated MM and MRS to use Modbus RTU Client and Modbus RTU Server terminology</li> </ol>  |

| Version | Date    | Notes   |
|---------|---------|---|
| 8.9.22  | 2/5/24  | <p>Features Added:</p> <ol style="list-style-type: none"> <li>1. Added priority-based reads for client protocols</li> <li>2. Added improved diagnostic timers for client protocols</li> <li>3. Reduced minimum delay between messages to zero ms on client protocols</li> <li>4. Added support for USB serial connections</li> <li>5. Added support for multiple connections on EtherNet/IP Adapter</li> <li>6. Added 100ms and 1000ms heartbeat values for diagnostic use</li> <li>7. Added configurable data size to EtherNet/IP adapter and DeviceNet Slave</li> <li>8. Added support for TTL communications on N34, NNA1, NNA4, N2E, and N2EW hardware</li> <li>9. Added support for JSON payloads to MQTT</li> <li>10. Added Network Bitmap Status to ASCII, USB, and TCP protocols</li> </ol> <p>Bug Fixes:</p> <ol style="list-style-type: none"> <li>11. Fixed COV Subscription Issues on BACnet MS/TP</li> <li>12. Fixed timing issues affecting gateway performance</li> <li>13. Fixed a bug where the Run Idle Header on the output instance for EtherNet/IP Scanner was not checked by default</li> </ol> |
| 8.9.29  | 4/1/24  | <p>Features Added:</p> <ol style="list-style-type: none"> <li>14. Added ability to do raw HEX byte copy when receiving data over ASCII, TCP, or USB.</li> </ol> <p>Bug Fixes:</p> <ol style="list-style-type: none"> <li>15. Fixed bug where function code 15 did not work on MM/MC.</li> <li>16. Fixed bug relating to writing zeros on start up on BS.</li> <li>17. Fixed bug where MQTT client did not appear in display data page when MQTT was paired with BACnet</li> </ol>   |
| 8.9.37  | 7/30/24 | <p>Bug Fixes:</p> <ol style="list-style-type: none"> <li>18. EIP IO Communication fixes</li> <li>19. Timing fixes</li> <li>20. USB Fixes <ol style="list-style-type: none"> <li>a. Inactivity Timeout</li> <li>b. Inactivity Timeout Logging</li> <li>c. Port Restart Logging</li> <li>d. Webpage fixes</li> </ol> </li> <li>21. ProfiNet Timing Fix</li> <li>22. EIP PanelView Fixes <ol style="list-style-type: none"> <li>a. Support for Explicit Messaging</li> </ol> </li> </ol>   |

## Overview

The 460MMSC-N2EW gateway Connects up to five Siemens S7 PLCs with as many as 32 Modbus RTU Servers. By following this guide, you will be able to configure the 460MMSC-N2EW gateway.

Number of ASCII devices is dependent on the Hardware and Product number of the 460 gateway.

For further customization and advanced use, please reference the appendices located online at: <http://www.rtautomation.com/product/460-gateway-support/>.

If at any time you need further assistance, do not hesitate to call Real Time Automation support. Support Hours are Monday-Friday 8am-5pm CST

Toll free: 1-800-249-1612

Email: [support@rtautomation.com](mailto:support@rtautomation.com)

## Hardware Platforms

The 460 Product Line supports a number of different hardware platforms. There are differences in how they are powered, what serial settings are supported, and some diagnostic features supported (such as LEDs). For these sections, be sure to identify the hardware platform you are using.

To find which hardware platform you are using:

- 1) Look on the front or back label of the unit for the part number.
- 2) On the webpage inside the gateway, navigate to the dropdown menu under **Other** and select **Utilities**. Click the **Listing of Revisions** button. The full part number is displayed here.

Once you have the full part number, the platform will be the number following the “-N”:





## Hardware – N2EW

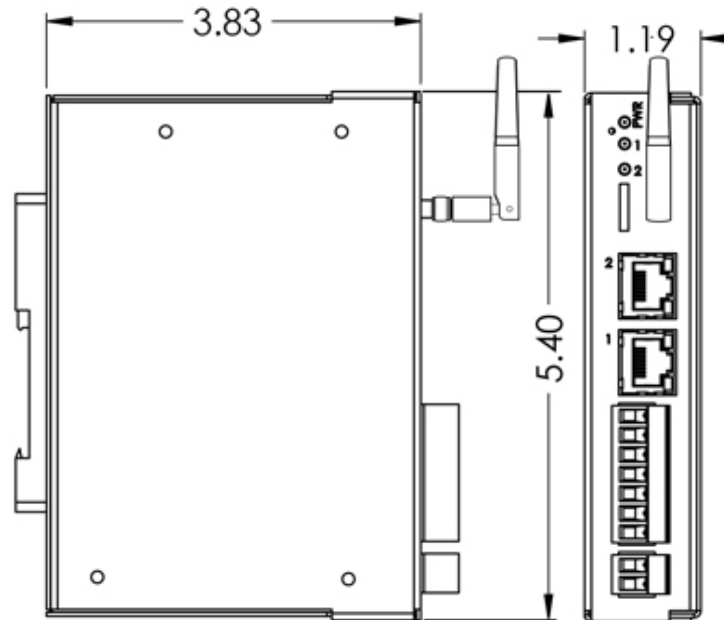

### Powering the Gateway

The following steps will allow you to properly and safely power the gateway.



**Warning:** Improper wiring will cause unit failure! Use the Screw Terminals power connection!

- 1) Connect a 12-24 VDC power source to the gateway, Red Wire = (+) Black Wire = (-).
  - a) The unit draws 8 VDC 900mA (7.2W) Max
  - b) The unit draws 35 VDC 900mA (31.5W) Max
  - c) The gateway has a voltage operating range from 8-35 VDC, 24 VDC is recommended.





## Hazardous Environment Power & Installation Instructions

This equipment is suitable for use in Class I, Division 2, Groups A, B, C and D, or non-hazardous locations only.

**WARNING – EXPLOSION HAZARD** - Do not disconnect equipment unless power has been removed or the area is known to be non-hazardous.

**WARNING – EXPLOSION HAZARD** - Substitution of components may impair suitability for Class I, Division 2.

**THIS EQUIPMENT IS AN OPEN-TYPE DEVICE AND IS MEANT TO BE INSTALLED IN AN ENCLOSURE SUITABLE FOR THE ENVIRONMENT SUCH THAT THE EQUIPMENT IS ONLY ACCESSIBLE WITH THE USE OF A TOOL.**

**WARNING – POWER JACK** (Screw Terminals, J7) IS FOR MAINTENANCE USE ONLY AND MAY ONLY BE USED WHILE THE AREA IS KNOWN TO BE FREE OF IGNITIBLE CONCENTRATIONS OF FLAMMABLE GASES OR VAPORS. IT IS NOT TO BE CONNECTED UNDER NORMAL OPERATION.

In Hazardous Environments the unit must be powered with between 8-35 VDC, 8 VDC @ 900 mA (7.2 W) max. Supervised. The unit is certified to be operated at -40°C to 50°C.



## Instructions d'alimentation et d'installation pour environnement dangereux

Cet équipement est conçu pour être utilisé uniquement dans des lieux de classe I, division 2, groupes A, B, C et D, ou non dangereux.

**AVERTISSEMENT - RISQUE D'EXPLOSION** - Ne débranchez pas l'équipement à moins que le courant ne soit coupé ou que la zone ne présente aucun danger.

**AVERTISSEMENT - RISQUE D'EXPLOSION** - La substitution de composants peut compromettre l'adéquation à la classe I, division 2.

**CET APPAREIL EST UN DISPOSITIF DE TYPE OUVERT ET IL FAUT L'INSTALLER DANS UN ENCEINTE ADAPTÉ À L'ENVIRONNEMENT TEL QU'IL N'EST ACCESSIBLE À L'UTILISATION D'UN OUTIL.**

**AVERTISSEMENT** - LE POWER JACK (bornes à vis, J7) est destiné exclusivement à la maintenance et ne peut être utilisé que lorsque la zone est connue pour être exempte de concentrations inintéressantes de gaz ou de vapeurs inflammables. IL NE DOIT PAS ÊTRE CONNECTÉ SOUS UN FONCTIONNEMENT NORMAL.

Dans les environnements dangereux, l'unité doit être alimentée entre 8-35 VDC, 8 VDC @ 900 mA (7,2 W) max. Supervisé. L'appareil est certifié pour fonctionner entre -40 ° C et 50 ° C.

## Port Configuration

The Port Configuration page is where you set port specific parameters. These settings must match the settings of the device(s) that you are connecting to.

Only 1 mode can be configured for this hardware. Below are the wiring pinouts for each mode.

When you have completed your port configuration, click the **Save Parameters** button.

### RS232 pinouts:

**Comm Ports Configuration**

Enable Port 0:

Mode: RS232

Serial Baud: 19200

Parity: None

Data Bits: 8

Stop Bits: 1

RS232

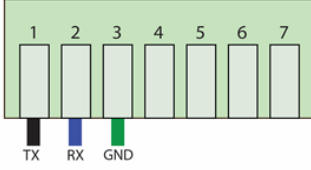

Save Parameters

### RS485 pinouts:

**Comm Ports Configuration**

Enable Port 0:

Mode: RS485 (2-wire:Half Duplex)

Serial Baud: 19200

Parity: None

Data Bits: 8

Stop Bits: 1

RS485 (2-Wire)

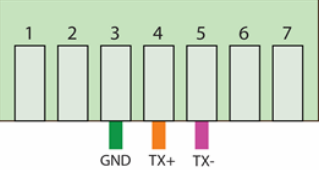

Save Parameters

## RS422 pinouts:

**Comm Ports Configuration**

Enable Port 0:

Mode: RS422 (4-wire:Full Duplex) ▾

Serial Baud: 19200 ▾

Parity: None ▾

Data Bits: 8 ▾

Stop Bits: 1 ▾

RS422 (4-Wire)

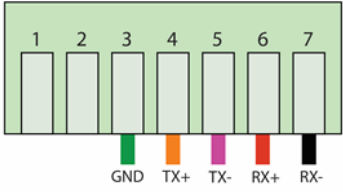

Save Parameters

## TTL pinouts:

**Comm Ports Configuration**

Enable Port 0:

Mode: TTL ▾

Serial Baud: 115200 ▾

Parity: None ▾

Data Bits: 8 ▾

Stop Bits: 1 ▾

TTL

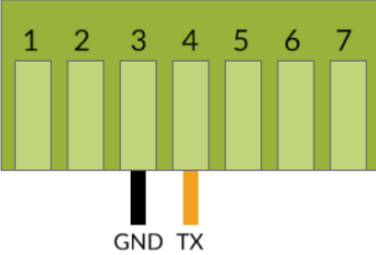

Save Parameters

## Mounting with a DIN Rail

### Installing

Follow these steps to install your interface converter.

- 1) Mount your DIN Rail.
- 2) Hook the bottom mounting flange under the DIN Rail.
- 3) While pressing the 460MMSC-N2EW against the rail, press up to engage the spring loaded lower clip and rotate the unit parallel to the DIN Rail.
- 4) Release upward pressure.

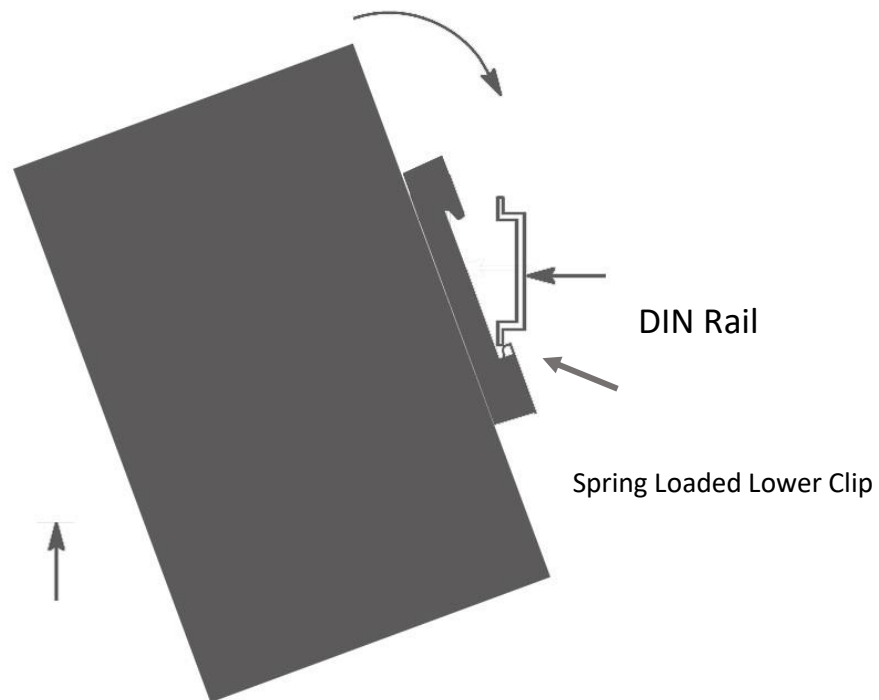

### Removing

Follow these steps to remove your interface converter.

- 1) Press up on unit to engage the spring loaded lower clip.
- 2) Swing top of the unit away from DIN Rail.

## Accessing the Main Page

The following steps will help you access the browser based configuration of the gateway. By default, DHCP is enabled. If the gateway fails to obtain an IP address over DHCP it will Auto IP with 169.254.X.Y. For more information on your Operating system network setting refer to the [Accessing Browser Configuration](#) document from our support web site.

- 1) Scan the QR code on the back of the unit or navigate to [www.rtautomation.com/460-gateway-support](http://www.rtautomation.com/460-gateway-support) and download IPSetup.exe.

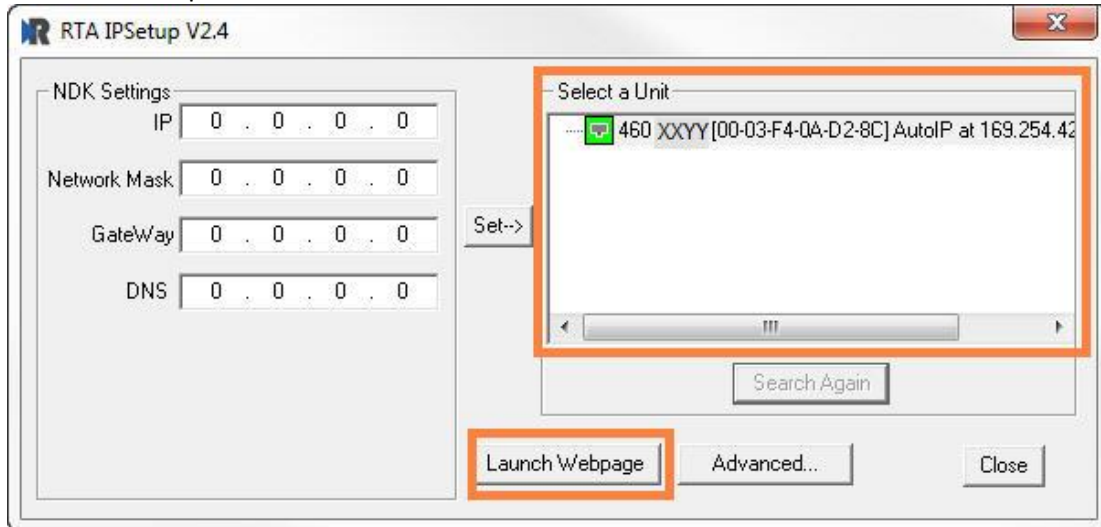

- 2) Run the IPSetup.exe program.
- 3) Find unit under "Select a Unit".
  - a. Change Gateway's IP address to match that of your PC if DHCP has failed.
    - i. You will know DHCP has failed if the gateway's IP address is AutoIP at 169.254.X.Y.
    - ii. If successful, it will say DHCP'd at ex: 192.168.0.100 or however your DCHP Client is set up.
  - b. If you do not see the gateway in this tool, then your PC is most likely set up as a static IP.
    - i. Change your PC's network settings to be DHCP. If DHCP fails, then it will change to be on the 169.254.x.y network.
    - ii. Relaunch the IP Setup tool to see if gateway can be discovered now.
- 4) Click **Launch Webpage**. The Main page should appear.

**Default setting is set to DHCP. If DHCP fails, default IP Address is 169.254.x.y**

## Error: Main Page Does Not Launch

If the Main Page does not launch, please verify the following:

- 1) Check that the PC is set for a valid IP Address
  - a. Open a MS-DOS Command Prompt
  - b. Type “ipconfig” and press enter
  - c. Note the PC’s IP Address, Subnet, and Default Gateway
- 2) The gateway must be on the same Network/Subnet as the PC whether it’s setup for DHCP or Static.  
Once you have both devices on the same network, you should be able to ping the gateway using a MS-DOS Command Prompt.



```
Administrator: C:\Windows\system32\cmd.exe

C:\>ping 192.168.0.100

Pinging 192.168.0.100 with 32 bytes of data:
Reply from 192.168.0.100: bytes=32 time<1ms TTL=60
Reply from 192.168.0.100: bytes=32 time<1ms TTL=60
Reply from 192.168.0.100: bytes=32 time<1ms TTL=60
Reply from 192.168.0.100: bytes=32 time<1ms TTL=60

Ping statistics for 192.168.0.100:
    Packets: Sent = 4, Received = 4, Lost = 0 (0% loss),
    Approximate round trip times in milli-seconds:
        Minimum = 0ms, Maximum = 0ms, Average = 0ms

C:\>
```

The Screenshot above shows a gateway that is currently set to a static IP Address of 192.168.0.100.

If you are able to successfully ping your gateway, open a browser and try to view the main page of the gateway by entering the IP Address of the gateway as the URL.



## Committing Changes to the Settings

All changes made to the settings of the gateway in Configuration Mode will not take effect until the gateway is restarted via the webpage. Changes will not be stored if the gateway's power is removed prior to a reboot.

**NOTE:** The gateway does not need to be restarted after every change. Multiple changes can be made before a restart, but they will not be committed until the gateway is restarted.

When all desired changes have been made, press the **Restart Now** button. The webpage will redirect to our rebooting page shown below:

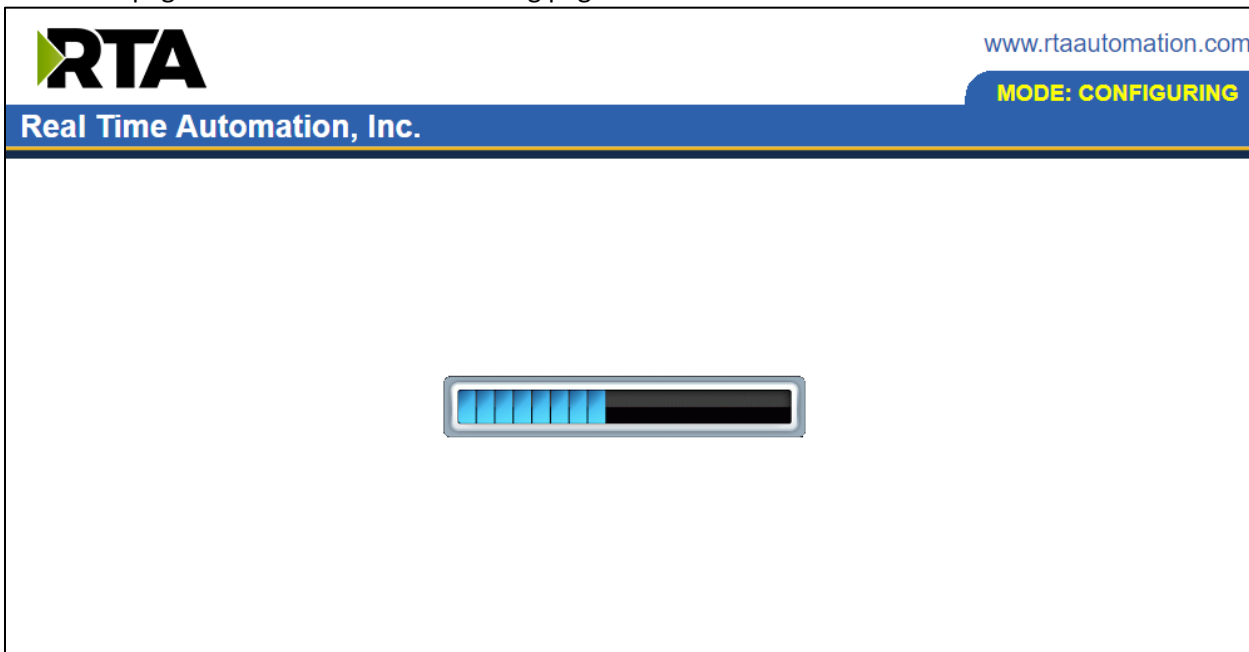

The reboot can take up to 20 seconds.

If the IP address has not been modified, the gateway will automatically redirect to the main page.

If the IP address was modified, a message will appear at the top of the page to instruct the user to manually open a new webpage at that new IP.



## Main Page

The main page is where important information about your gateway and its connections are displayed.

Mode (orange box below):

Running Mode:

- Protocol communications are enabled
- Configuration cannot be changed during Running Mode. If changes are needed, click the **Configuration Mode** button shown in the green box below

Configuring Mode:

- Protocol communication is stopped and no data is transmitted
- Configuration is allowed

Navigation (green box below):

You can easily switch between modes and navigate between pages (Configuration, Diagnostics, and Other pages) using the buttons on the left hand side.



The screenshot shows the RTA Main Page interface. At the top left is the RTA logo and 'Real Time Automation, Inc.'. At the top right is the website 'www.rtaautomation.com' and a status box indicating 'MODE: RUNNING' and '460ETCMC'. On the left side, there is a navigation menu with buttons for 'Configuration Mode' (highlighted in green), 'Main Page', 'CONFIGURATION' (with sub-options: Network Configuration, Allen-Bradley PLC, Modbus TCP/IP Client, Display Data), 'DIAGNOSTICS' (with a '-Select-' dropdown), and 'OTHER' (with a '-Select-' dropdown). The main content area is titled 'Main Page' and includes a 'Device Description' field with the value 'Application Description' and a 'Save Parameters' button. Below this are several status sections: 'Network Status' (table with columns: Ethernet Port, Link Status, MAC Address, IP Address), 'Allen-Bradley PLC Status', 'Modbus TCP/IP Client Status', and 'Data Mapping Status'.

| Ethernet Port | Link Status          | MAC Address       | IP Address |
|---------------|----------------------|-------------------|------------|
| Ethernet Port | 100Mbps, Full Duplex | 00:03:F4:0A:43:CC | 10.1.28.95 |

**Allen-Bradley PLC Status**  
 Device Status: Fatal Error: No Configuration  
 Last Read Error Code:  
 Last Write Error Code:  
 LED Status: Connection Status: No Devices Configured / Enabled

**Modbus TCP/IP Client Status**  
 Device Status: Fatal Error: No Configuration  
 Last Error Code:  
 LED Status: Connection Status: No Devices Configured / Enabled

**Data Mapping Status**  
 # Enabled: 0 of 0  
 # of Errors: 0  
 First Error:

## Device Configuration

The device configuration area is where you assign the device description parameter. Changes can only be made when the gateway is in Configuration Mode.

**Main Page**

Device Description:

Once you are done configuring the Description, click the **Save Parameters** button.

## Network Configuration

The network configuration area is where you assign the IP address and other network parameters. Changes can only be made when the gateway is in Configuration Mode.

Once you are done configuring the Network Settings, click the **Save Parameters** button.

If you are changing the IP Address of the gateway, the change will not take effect until the unit has been rebooted. After reboot, you must enter the new IP Address into the URL.

### Network Configuration

#### Ethernet Switch Configuration

Independent ▾

#### Ethernet Port 1 Configuration

Ethernet MAC Address: 00:03:F4:0B:82:26  
Ethernet Link: Auto-Negotiate ▾  
IP Setting: Static ▾  
IP Address: 10.1.16.49  
Subnet: 255.255.0.0  
Default Gateway: 0.0.0.0  
DNS Gateway: 0.0.0.0

Save Parameters

#### Ethernet Port 2 Configuration

Ethernet MAC Address: 00:03:F4:0B:82:EE  
Ethernet Link: Auto-Negotiate ▾  
IP Setting: DHCP ▾  
IP Address: 0.0.0.0  
Subnet: 0.0.0.0  
Default Gateway: 0.0.0.0  
DNS Gateway: 0.0.0.0

Save Parameters

#### Wifi Configuration

Wifi MAC Address: 00:03:F4:0C:BC:98  
SSID:  Scan  
Password:   
IP Setting: DHCP ▾  
IP Address: 0.0.0.0  
Subnet: 0.0.0.0  
Default Gateway: 0.0.0.0  
DNS Gateway: 0.0.0.0

Save Parameters

## Network Interface Options

The N2EW hardware has three different Network Interface options, Independent Mode, Switch Mode and Wi-Fi Mode. Below, you can find the different use cases that each interface option allows for.

### Independent Mode

- 1) Two Ethernet-based protocols on the same IP Network
  - a) Ethernet Port 1 used OR
  - b) Ethernet Port 2 used OR
  - c) Wi-Fi used OR
  - d) Ethernet Port 1 & 2 used
- 2) Two Ethernet-based protocols on different IP Networks
  - a) Ethernet Port 1 used AND
  - b) Ethernet Port 2 used AND
  - c) Wi-Fi used

**Switch Mode** – Only Ethernet Port 1 is used for protocol communication

- 1) One Ethernet-based protocol on the IP Network (layer-2 switch)
  - a) Ethernet Port 1 used for direct protocol communication
  - b) Ethernet Port 2 available for daisy chaining devices together
    - i) A Ring topology is NOT supported
- 2) Two Ethernet-based protocols on same IP Network
  - a) Ethernet Port 1 used for direct protocol communication with another switch, hub, or router
  - b) Ethernet Port 2 available for a daisy chaining devices together
    - i) A Ring topology is NOT supported
- 3) Two Ethernet-based protocols on different IP Networks
  - a) Not Possible – must use Independent Mode

**Wireless Mode** – Only Wi-Fi is used for protocol communication

- 1) Two Ethernet-based protocols on the same IP Network into a Router

**It is recommended to leave the DNS Gateway set to 0.0.0.0 and the Ethernet Link as Auto-Negotiate. If configuring the gateway to use E-mail, the DNS Gateway must be set.**

## Modbus RTU Client Configuration

Click the **Modbus RTU Client** button to access the configuration page.

- 1) **Serial Port:** Select which serial port is being used for communication. This port must be configured on the Port Configuration page. If it has not yet been configured, it will display *Disabled* after the Port descriptions in this dropdown.

Serial Port: Port 0 (T-Strip) Disabled

- 2) **Delay Between Messages:** Enter the length of time to delay between read and write scan line requests (ms).
- 3) **Response Timeout:** Enter the amount of time the gateway should wait before a timeout is issued for a read/write request (ms).
- 4) **Dependency Protocol:** If enabled, Modbus RTU Client communication will stop if communication to the selected protocol is lost.
- 5) **Read High Priority:** Configures the number of high priority requests to process before switching to low priority requests. This number should be higher than the Read Low Priority.
- 6) **Read Low Priority:** Enter the number of low priority requests to process before switching to high priority requests. This number should be lower than the Read High Priority.
- 7) **Read All Data Points Once:** If Enabled, the gateway will read all configured data points once on startup regardless of priority, then begin processing requests based on priority after all points have been read once.

**Modbus RTU Client Configuration**
Help

Serial Port: Port 0 Disabled

Delay Between Messages:  0-60000 ms

Response Timeout:  50-60000 ms

Dependency Protocol: None

Read High Priority:  1-60000

Read Low Priority:  1-60000

Read All Data Points Once:

## Modbus RTU Client Device Configuration

The bottom area of the Modbus RTU Client Configuration page lets you configure up to 32 external Modbus RTU server devices.

- 1) To add additional server connections, click the -Select- dropdown under Modbus RTU Client Device List and select **Add Generic Server** option.

**Modbus RTU Client Device List**

-Select- Delete Slave  
<< 0 >>  
 0-0

- a) If you are configuring multiple devices click << or >> to navigate to another device.
  - b) To create a new server with the same parameters already configured from another server, click the -Select- dropdown and select the **Add from Modbus RTU X** option (where X represents the server you wish to copy parameters from). Once created, you can make any additional changes needed to that new server.
  - c) To remove a device, navigate to the server to delete using the << and >> buttons and click the **Delete Server** button.
  - d) Click the **Save Parameters** button to save changes before restarting or going to another configuration page.
- 2) The **Enable** check box should be selected for the device.
  - 3) Enter a **Device Label** to identify the device within the gateway.
  - 4) Enter a unique Modbus RTU **Server Address** for the device on the network.
  - 5) **Force Function Code 15/16 for Single Writes:** Only select this if the Modbus RTU device does not support Modbus Function Code 5/6.

|   |   |  |
|---|---|--|
| <input checked="" type="checkbox"/> <b>Enable</b>   | <b>Modbus RTU Server 1</b>                        |  |
| Device Label <input type="text" value="MM01"/>  | Server Address <input type="text" value="1"/>     | 0-255  |
| Force Function Code 15/16 for Single Writes <input type="checkbox"/>  | Enable 0-Base Addressing <input type="checkbox"/> |  |
| Bit Pack <span style="border: 1px solid gray; padding: 2px;">1 Bit</span> <span style="font-size: small;">Coil / Input Status Only</span> | Enable Modbus ASCII <input type="checkbox"/>      |  |
| Swap Indicator <span style="border: 1px solid gray; padding: 2px;">None</span> <span style="font-size: small;">v</span>                   |   |  |
| # of Read Scan Lines <input type="text" value="0"/>   | 0-100   | # of Write Scan Lines <input type="text" value="0"/> |
| <span style="border: 1px solid gray; padding: 2px 10px;">Generate Scan Lines</span>   |   |  |

- 6) **Enable 0-Based Addressing:** Check ONLY if the server you are connecting to begins their register numbering at 0 OR they specify that their device addresses are 0-based.

- 7) **Bit Pack:** Select the formatting of the Coil Status/Input Status. Automap will use this packing size to map coils to/from the other protocol. The bit pack selection here should match that of the other protocol. The starting address is considered Bit 0 and is the low-order bit.
- 8) **Enable Modbus ASCII:** Only select this if your Modbus device is also using ASCII messaging. By default, the device will use Modbus RTU.
- 9) To enable data swapping, select the required **Swap Indicator**. If the bytes appear in the wrong order, enable swapping to change the data. This swapping does *NOT* change Coils and their ordering inside the Bit Pack.
- 10) Enter the number of Read Scan Lines and Write Scan Lines.
- 11) Click the **Generate Scan Lines** button to have the read and write scan lines auto-generate for you. You may manually configure the read and write scan lines after they have been generated.

## Configuring Read and Write Scan Lines

Follow these steps to manually configure Read and Write Scan Lines.

- 1) Click the **View Read Scan Lines** or **View Write Scan Lines** button.

View Read Scan Lines
View Write Scan Lines

### Read Scan Lines (Modbus RTU to 460ESMM)

|                          | Line # | Priority | Point Type       | Starting Address | # of Points<br><small>*See Limits Below</small> |
|--------------------------|--------|----------|------------------|------------------|---|
| <input type="checkbox"/> | 1      | High ▾   | 0x Coil Status ▾ | 1                | 1   |

<< 1-1 >>

View Read Scan Lines
View Write Scan Lines

### Write Scan Lines (460 to Modbus RTU)

|                          | Line # | Point Type       | Starting Address | # of Points<br><small>*See Limits Below</small> |
|--------------------------|--------|------------------|------------------|---|
| <input type="checkbox"/> | 1      | 0x Coil Status ▾ | 1                | 1   |

<< 1-1 >>

- 2) Select a Point Type for each Scan Line. Options include: Coil Status, Input Status, Input Registers, and Holding Registers.
  - a) **Note:** Input/Holding Registers have a data type associated with them.
  - b) String Point Type- If the mating protocol supports strings, you may select string as a point type in Modbus. With this point type, 2 characters will be packed into a single register and the first register will be set aside for the length.
  - c) **EX:** 4x Hold Reg (String) with a Starting Address of 1 for a length of 5 Registers, this means that Register 1 will hold the length of the string and Registers 2-5 will hold the string contents. So, this string can contain a max of 8 characters.
- 3) Enter a Starting Address (This will be 1 based, if your device is 0 based then check the Enabled 0-Based Addressing box).
  - a) **Note:** Some manufactures' documentation may call out the Starting Address as 00001, 10001, 30001 or 40001. Don't include the first value as this represents (0) coil, (1) Input Status, (3) Input Register and (4) Holding Register.



| <input checked="" type="checkbox"/> Enable  |                          | Modbus RTU Server 1      |  |
|---|--------------------------|--------------------------|--|
| Device Label                                | MM01                     | Server Address           | 1 0-255                                      |
| Force Function Code 15/16 for Single Writes | <input type="checkbox"/> | Enable 0-Base Addressing | <input type="checkbox"/>                     |
| Bit Pack                                    | 1 Bit                    | Coil / Input Status Only | Enable Modbus ASCII <input type="checkbox"/> |
| Swap Indicator                              |                          | None                     |  |
| # of Read Scan Lines                        | 0 0-100                  | # of Write Scan Lines    | 0 0-100                                      |
| Generate Scan Lines                         |                          |                          |  |

- 4) Enter the # of consecutive points to read for that point/data type. See the *Scan Line Data Limit* section at the bottom of the webpage for max values in a scan line.

**Scan Line Data Limit**

| Point Type                               | Length Range |
|--|--------------|
| Coil Status                              | 512          |
| Input Status                             | 512          |
| Input Register (16 Bit Int/Uint)         | 125          |
| Input Register (32 Bit Int/Uint/Float)   | 62           |
| Input Register (64 Bit Int/Uint/Float)   | 31           |
| Input Register (String - 2 char/reg)     | 125          |
| Holding Register (16 Bit Int/Uint)       | 125          |
| Holding Register (32 Bit Int/Uint/Float) | 62           |
| Holding Register (64 Bit Int/Uint/Float) | 31           |
| Holding Register (String - 2 char/reg)   | 125          |

- 5) When configuring read scanlines there is an optional priority configuration. There are three priority selections available, how often each priority is read is configurable in the Modbus RTU Client Configuration section using the Read High Priority and Read Low Priority Configurations.
- High: Read the scanline based on the Read High Priority configuration.
  - Low: Read the scanline based on the Read Low Priority configuration.
  - Once: Read the scanline once on gateway startup or upon a new connection and never again during normal operation.

**Read Scan Lines (Modbus RTU to 460ESMM)**

| <input type="checkbox"/> |  | Line # | Priority | Point Type     | Starting Address | # of Points<br>*See Limits Below |
|--------------------------|--|--------|----------|----------------|------------------|----------------------------------|
| <input type="checkbox"/> |  | 1      | High     | 0x Coil Status | 1                | 1                                |
|                          |  |        | High     | << 1-1 >>      |                  |                                  |
|                          |  |        | Low      |                |                  |                                  |
|                          |  |        | Once     |                |                  |                                  |
| Save Parameters          |  |        |          |                |                  |                                  |

## S7 Client Configuration

Click the **S7 Client PLC** button to access the configuration page.

- 1) Select which **Network Interface** to use for this S7 client PLC connection. If using single port hardware, the Network Interface will default to Ethernet Port only.
- 2) **Delay Between Messages:** Enter the length of time to delay between read and write scan line requests (ms).
- 3) **Response Timeout:** Enter the amount of time the gateway should wait before a timeout is issued for a read/write request (ms).
- 4) **Delay Between Connect Attempts:** Enter the amount of time the gateway should wait between attempts to connect to the PLC.
- 5) **Dependency Protocol:** If enabled, the Siemens S7 PLC communication will stop if communication to the selected protocol is lost.
- 6) **Read High Priority:** Configures the number of high priority requests to process before switching to low priority requests. This number should be higher than the Read Low Priority.
- 7) **Read Low Priority:** Enter the number of low priority requests to process before switching to high priority requests. This number should be lower than the Read High Priority.
- 8) **Read All Data Points Once:** If Enabled, the gateway will read all configured data points once on startup regardless of priority, then begin processing requests based on priority after all points have been read once.

**S7 Client Configuration**
Help

Network Interface:  ▾

Delay Between Messages:  0-60000 ms

Response Timeout:  50-60000 ms

Delay Between Connect Attempts:  1000-60000 ms

Dependency Protocol:  ▾

Read High Priority:  1-60000

Read Low Priority:  1-60000

Read All Data Points Once:

## External Server Configuration

The bottom area of the S7 Client Configuration page lets you configure up to 5 external S7 server devices.

- 1) To add additional server connections, click the -Select- dropdown under S7 Client Device List and select **Add Generic Server** option.

**S7 Client Device List**

1-2

- a) If you are configuring multiple devices click << or >> to navigate to another device.
  - b) To create a new server with the same parameters already configured from another server, click the -Select- dropdown and select the **Add from S7 X** option (where X represents the server you wish to copy parameters from). Once created, you can make any additional changes needed to that new server.
  - c) To remove a device, navigate to the server to delete using the << and >> buttons and click the **Delete Server** button.
  - d) Click the **Save Parameters** button to save changes before restarting or going to another configuration page.
- 2) The **Enable** check box should be selected for the device.
  - 3) Enter a **Device Label** to identify the device within the gateway.
  - 4) Enter the unique **IP Address** that matches the server. If this value doesn't match, the gateway will timeout.
  - 5) Enter the **Rack** number of the S7 server. If this value doesn't match, the gateway will not be able to open a connection.
  - 6) Enter the **Slot** number of the S7 server. If this value doesn't match, the gateway will not be able to open a connection.
  - 7) Enter the number of Read Scan Lines and Write Scan Lines.
  - 8) Click the **Generate Scan Lines** button to have the read and write scan lines generated for you.

|   |  |  |  |
|---|--|--|--|
| <input type="checkbox"/> <b>Enable</b>                    | <b>S7 Server 1</b>   |  |  |
| Device Label <input type="text" value="SC01"/>            | IP Address <input type="text" value="0.0.0.0"/>            |  |  |
| Rack <input type="text" value="0"/> 0-65535               | Slot <input type="text" value="0"/> 0-65535                |  |  |
| # of Read Scan Lines <input type="text" value="0"/> 0-150 | # of Write Scan Lines <input type="text" value="0"/> 0-150 |  |  |
| <input type="button" value="Generate Scan Lines"/>        |  |  |  |
| <input type="button" value="View Read Scan Lines"/>       |  | <input type="button" value="View Write Scan Lines"/> |  |

## Configuring Read and Write Scan Lines

Follow these steps to manually configure read and write scan lines.

- 1) Click the **View Read Scan Lines** or **View Write Scan Lines** button.

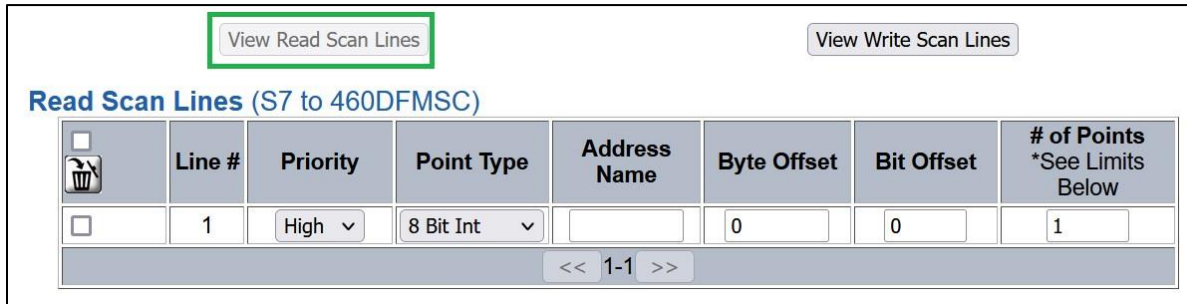

| <input type="checkbox"/> | Line # | Priority | Point Type | Address Name | Byte Offset | Bit Offset | # of Points<br>*See Limits Below |
|--------------------------|--------|----------|------------|--------------|-------------|------------|----------------------------------|
| <input type="checkbox"/> | 1      | High     | 8 Bit Int  |              | 0           | 0          | 1                                |

<< 1-1 >>

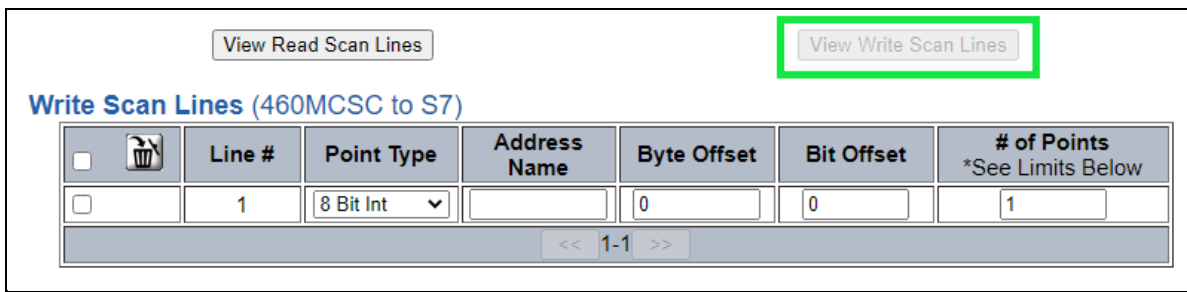

| <input type="checkbox"/> | Line # | Point Type | Address Name | Byte Offset | Bit Offset | # of Points<br>*See Limits Below |
|--------------------------|--------|------------|--------------|-------------|------------|----------------------------------|
| <input type="checkbox"/> | 1      | 8 Bit Int  |              | 0           | 0          | 1                                |

<< 1-1 >>

- 2) Select a **Point Type** for each scan line. Options include: 8 Bit Int, 16 Bit Int, 32 Bit Int, 32 Bit Float, Bool, Char.
  - a) **Char Point Type:** When using a Char Data Type, the 1<sup>st</sup> byte of each Memory address is reserved for the Length field. The remaining bytes will be used for the actual data. You must use an array of Char. String data type is not supported.
- 3) Select an **Address Name**- Choose if the data address is an input address(I), output address(Q) or Data Block(DB#).
  - a) **Note:** Input address(I) is only available in the RTA gateway write direction (460SC to S7)
- 4) Enter a **Byte Offset** - Enter the first data address you want to read/write within the scan line.
- 5) Enter a **Bit Offset** - Only for Bool data type. Enter the offset to the desired bit of the data address you want to read/write within the scan line.
  - a) Bits are organized from left to right, 7 down to 0. The value will be set to 0 for non-Bool data types.
- 6) Enter the **# of consecutive points** to read for that point/data type. See the *Scan Line Data Limit* section at the bottom of the webpage for max values in a scan line.
- 7) When configuring read scanlines there is an optional priority configuration. There are three priority selections available, how often each priority is read is configurable in the S7 Client Configuration section using the Read High Priority and Read Low Priority Configurations.

- a) High: Read the scanline based on the Read High Priority configuration.
- b) Low: Read the scanline based on the Read Low Priority configuration.
- c) Once: Read the scanline once on gateway startup or upon a new connection and never again during normal operation.

**Read Scan Lines (S7 to 460DFMSC)**

| <input type="checkbox"/> | Line # | Priority  | Point Type                                     | Address Name | Byte Offset | Bit Offset | # of Points<br>*See Limits Below |
|--------------------------|--------|---|--|--------------|-------------|------------|----------------------------------|
| <input type="checkbox"/> | 1      | High  | 8 Bit Int                                      |              | 0           | 0          | 1                                |
|                          |        | <ul style="list-style-type: none"> <li>High</li> <li>Low</li> <li>Once</li> </ul> | <input type="button" value="Save Parameters"/> |              |             |            |                                  |

Example 1: 8 Bit Int, I Address, Byte 10, Offset 0, with # of Points 5 will Read memory addresses IB10 to IB14.

| <input type="checkbox"/>                       | Line # | Point Type | Address Name | Byte Offset | Bit Offset | # of Points<br>*See Limits Below |
|--|--------|------------|--------------|-------------|------------|----------------------------------|
| <input type="checkbox"/>                       | 1      | 8 Bit Int  | I            | 10          | 0          | 5                                |
| <input type="button" value="Save Parameters"/> |        |            |              |             |            |                                  |

Example 2: 16 Bit Int, Q Address, Byte 10, Offset 0, with # of Points 5 will write memory addresses IW10 to IW19. Address 10-11 will be first 16-bit int, 12-13 will be the second 16-bit int, etc.

| <input type="checkbox"/>                       | Line # | Point Type | Address Name | Byte Offset | Bit Offset | # of Points<br>*See Limits Below |
|--|--------|------------|--------------|-------------|------------|----------------------------------|
| <input type="checkbox"/>                       | 1      | 16 Bit Int | Q            | 10          | 0          | 5                                |
| <input type="button" value="Save Parameters"/> |        |            |              |             |            |                                  |

Example 3: 32 Bit Float, I Address, Byte 10, Offset 0, with # of Points 5 will read memory addresses ID10 to ID29. Address 10-13 will be first 32-bit float, 14-17 will be the second 32-bit int, etc.

| <input type="checkbox"/>                       | Line # | Point Type   | Address Name | Byte Offset | Bit Offset | # of Points<br>*See Limits Below |
|--|--------|--------------|--------------|-------------|------------|----------------------------------|
| <input type="checkbox"/>                       | 1      | 32 Bit Float | I            | 10          | 0          | 5                                |
| <input type="button" value="Save Parameters"/> |        |              |              |             |            |                                  |

Example 4: 16 Bit, DB5 Address, Byte 10, Offset 0, with # of Points 5 will read memory addresses of DB5.DBX10. Address DB5.DBX10 will be first 16 bit, DB5.DBX12 will be next, etc.

| <input type="checkbox"/>           |  | Line # | Point Type   | Address Name | Byte Offset | Bit Offset | # of Points<br><small>*See Limits Below</small> |
|------------------------------------|---|--------|--------------|--------------|-------------|------------|---|
| <input type="checkbox"/>           |   | 1      | 16 Bit Int ▼ | DB5          | 10          | 0          | 5   |
| <input type="button" value="1-1"/> |   |        |              |              |             |            |   |

**Terminology Note and Example:** I addresses refer to input, Q addresses refer to output, %B refers to bytes and %W refers to words %D refers to DWord. Example, %IB68 would be used to read the byte offset based on the number of points. If reading a input/output for Bool, the bit offset would read the bit. Example, %I68.0 - %I68.7 or %Q68.0 - %68.7

## Configuring Read and Write Scan Lines (cont.)

If you are configuring multiple devices, click << or >> to navigate to another device. If this is the only device you are configuring, click the **Save Parameters** button.

Below is the Scan Line Data Limit for each Point Type and the max length range associated to them.

| Scan Line Data Limit |                 |
|----------------------|-----------------|
| Point Type           | Max # of Points |
| 8 Bit Int            | 400             |
| 16 Bit Int           | 200             |
| 32 Bit Int           | 100             |
| 32 Bit Float         | 100             |
| Bool                 | 1               |
| Char                 | 255             |

**Important Note:** When trying to read or write values via S7 communications, you MUST enable the permit access PUT/GET option in your PLC under the Protection and Security with TIA Portal.

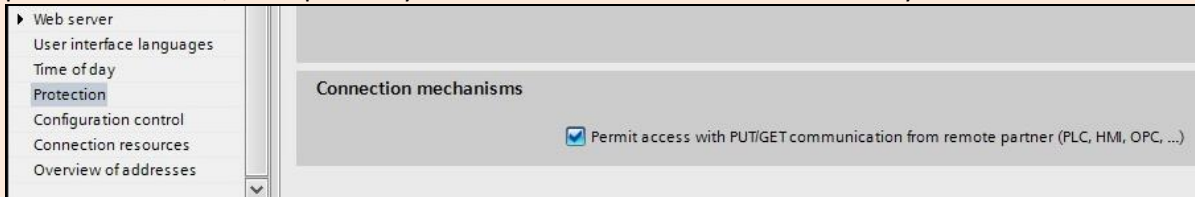

**Important Note:** When trying to read or write values via S7 communications, you MUST disable the Optimized block access in Attribute's under the DB# properties setting.

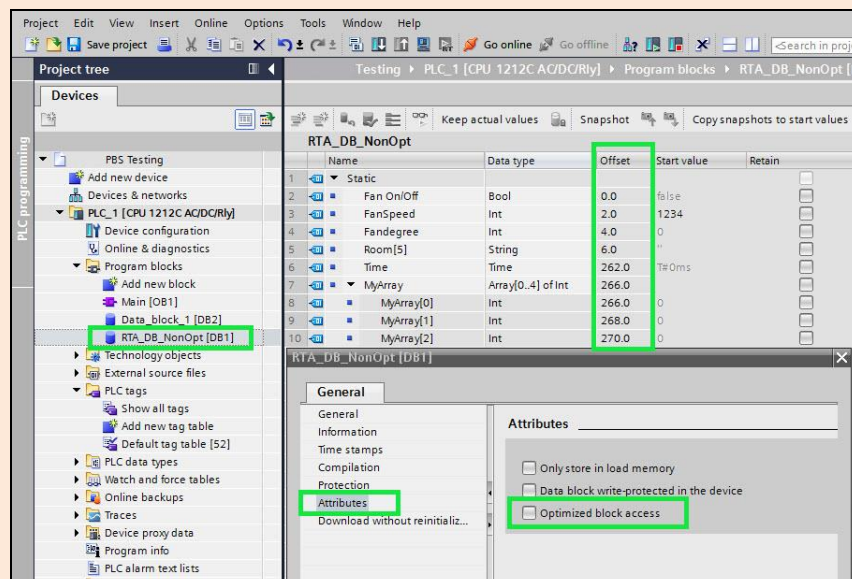

## Mapping - Transferring Data Between Devices

There are 5 ways to move data from one protocol to the other. You can combine any of the following options to customize your gateway as needed.

**Option 1 – Data Auto-Configure Mappings:** The gateway will automatically take the data type (excluding strings) from one protocol and look for the same data type defined in the other protocol. If there isn't a matching data type, the gateway will map the data to the largest available data type. See Data Auto-Configure section for more details.

**Option 2 – String Auto-Configure:** The gateway will automatically take the string data type from one protocol and map it into the other. See String Auto-Configure section for more details.

**Option 3 – Manual Configure Mappings:** If you don't want to use the Auto-Configure Mappings function, you must use the manual mapping feature to configure translations.

**Option 4 – Manipulation/Scaling:** You can customize your data by using math operations, scaling, or bit manipulation. See Data Mapping-Explanation section for more details.

**Option 5 – Move Diagnostic Information:** You can manually move diagnostic information from the gateway to either protocol. Diagnostic information is not mapped in Auto-Configure Mappings Mode. See Diagnostic Info section for more details.

**Going from Manual Mapping to Auto-Mapping will delete ALL mappings and manipulations configured.**



## Display Mapping and Values

The Display Data and Display String pages are where you can view the actual data for each mapping that is set up.

### Display Data

Click the **Display Data** button to view how the data is mapped and what the values of each mapping are.

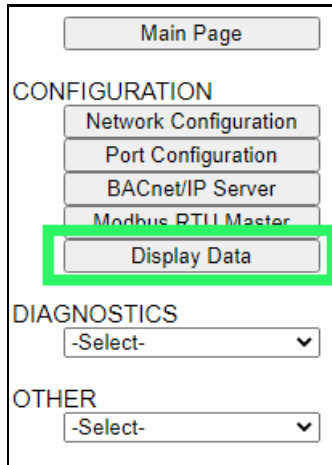

Here you will see how each data point (excluding strings) is mapped. To view, select the device from the dropdown menu and click **View** to generate the information regarding that device. Then select either the **Protocol 1 to Protocol 2** or **Protocol 2 to Protocol 1** button, correlating to the direction you wish to see the data.



This page is very useful when verifying that all data is mapped somehow from one protocol to another. If a data point is not mapped, it will display on this page in a yellow highlighted box. The Display Data page will display up to 200 mappings per page, simply navigate to the next page for the additional mapping to display.

| Modbus RTU |             |              | BACnet/IP |                            |  |
|------------|-------------|--------------|-----------|----------------------------|--|
| Name       | Value (Hex) | Manipulation | Name      | Value (Hex)                |  |
| 400001     | -- --       | →→           | AI1       | -- --                      |  |
| 400002     | -- --       | →→           | AI2       | Mapping Disabled for Point |  |
| 400003     | -- --       | →→           | AI3       | -- --                      |  |

In the above example, we see the following:

- Modbus register 400001 from Slave 1 is being mapped to AI1 on BACnet
- Nothing is being moved from Modbus register 400002 to AI2 on BACnet because the mapping is disabled
- Modbus register 400003 from Slave 1 is being mapped to AI3 on BACnet

**NOTE:** If a data point is mapped twice, only the first instance of it will show here. EX: If Modbus 400001 & 400040 from Slave 1 are both mapped to AI1, only 400001 will show as being mapped to AI1.

If there are values of "--" on this page, it indicates that the source has not yet been validated and no data is being sent to the destination.

The example below reflects the Modbus to PLC flow of data. The Modbus (left side) is the source and the PLC (right side) is the destination.

- The 460 gateway has received valid responses from Modbus registers 400001- 400005 and therefore can pass the data on to the PLC tag called MC2PLC\_INT.
- The 460 gateway has NOT received valid responses from Modbus register 400011 & 400012. As a result, the data cannot be passed to the PLC tag ETC01\_GN0\_INT2 and indicates so by using "--" in the value column of the table.

### Display Data Edit Mapping View as Text

Select a Device Modbus TCP Server IP Address: 10.1.16.16 View

Modbus TCP/IP to PLC
PLC to Modbus TCP/IP

<<
1
>>

Displaying 1-7 of 7

| Modbus TCP/IP |             |        | 460ETCMC<br>↔↔ | PLC                        |             |        |
|---------------|-------------|--------|----------------|----------------------------|-------------|--------|
| Name          | Value (Hex) |        | Manipulation   | Name                       | Value (Hex) |        |
| 400001        | 15          | 0x000F | ↔↔             | ETC01<br>MC2PLC_INT[0]     | 15          | 0x000F |
| 400002        | 1495        | 0x05D7 | ↔↔             | ETC01<br>MC2PLC_INT[1]     | 1495        | 0x05D7 |
| 400003        | 1           | 0x0001 | ↔↔             | ETC01<br>MC2PLC_INT[2]     | 1           | 0x0001 |
| 400004        | 23          | 0x0017 | ↔↔             | ETC01<br>MC2PLC_INT[3]     | 23          | 0x0017 |
| 400005        | 3           | 0x0003 | ↔↔             | ETC01<br>MC2PLC_INT[4]     | 3           | 0x0003 |
| 400011        | --          | --     | ↔↔             | ETC01<br>ETC01_G2N0_INT[0] | --          | --     |
| 400012        | --          | --     | ↔↔             | ETC01<br>ETC01_G2N0_INT[1] | --          | --     |

To view the actual data mappings, click the **Edit Mapping** button. For more details, see the Data Mapping-Explanation section.

To view the data mappings purely as text, click the **View as Text** button. For more details, see the View Data Mapping as Text section.

## Display String

Click the **Display String** button to view what the values of each Parsing and/or Concatenating strings are, you can also click on the Edit Mapping to view the mapping of each string.

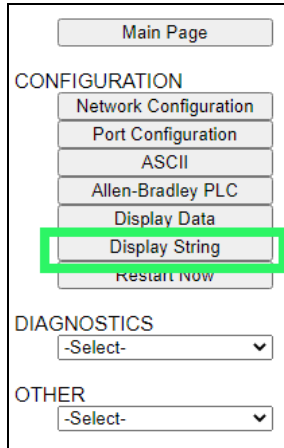

Main Page

CONFIGURATION

- Network Configuration
- Port Configuration
- ASCII
- Allen-Bradley PLC
- Display Data
- Display String**
- Restart Now

DIAGNOSTICS

-Select-

OTHER

-Select-

To view the source or destination groups from a string, click the dropdown menu to generate the information regarding that device. The string data will be displayed in both Hex and ASCII (only the ASCII data is sent). The example below shows data that is coming from the source device. A group will be displayed for each Parsing/Concatenating String field that is configured.



**Display String** Edit Mapping View as Text

Select a Group **Src: Line 1 Barcode Scanner** and a String **Barcode Scanner** (11 bytes)

0000: 68 65 6C 6C 6F 20 77 6F 72 6C 64      hello world

In the Group drop down, “Line1” is defined on the ASCII Device configuration page and “Barcode Scanner” is defined in the ASCII Parsing configuration.

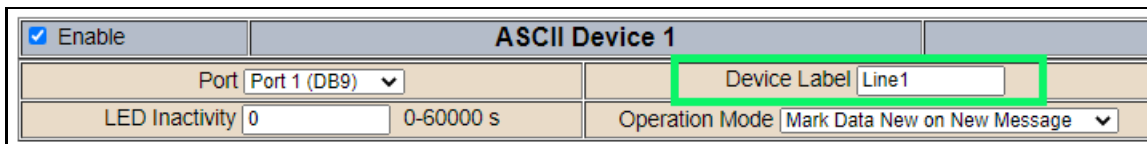

Enable      **ASCII Device 1**

Port **Port 1 (DB9)**      Device Label **Line1**

LED Inactivity **0**      0-60000 s      Operation Mode **Mark Data New on New Message**

| Field | Start Location | Length | Data Type | Internal Tag Name      |
|-------|----------------|--------|-----------|------------------------|
| 1:    | 1              | 0      | String    | <b>Barcode Scanner</b> |

If there are values of “Data Not Valid “on this page, it indicates that the source has not been validated yet and no data is being sent to the destination.



**Display String** Edit Mapping  
View as Text

Select a Group  and a String  (0 bytes)

Data Not Valid

**NOTE:** You can view the whole string data by clicking on **Diagnostics Info** drop down and navigating to ASCII Diagnostics page. You will also have to select the port you want to view in the dropdown below ASCII.

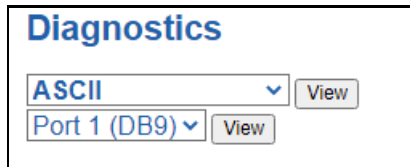

**Diagnostics**

View

View

To view the string mappings, click the **Edit Mapping** button. For more details see the **String Mapping-Explanation** section.

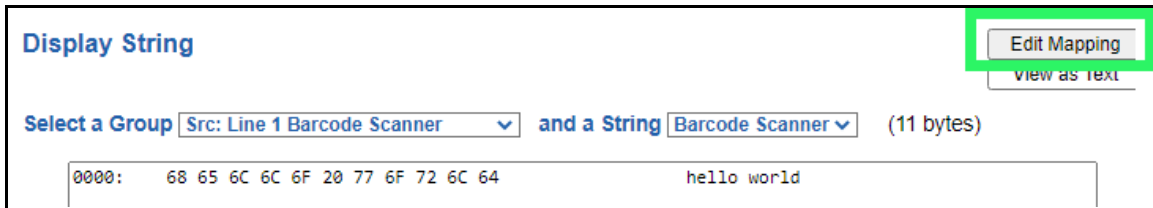

**Display String** Edit Mapping  
View as Text

Select a Group  and a String  (11 bytes)

0000: 68 65 6C 6C 6F 20 77 6F 72 6C 64 hello world

**NOTE: Only String data types can be mapped to another String data type.**

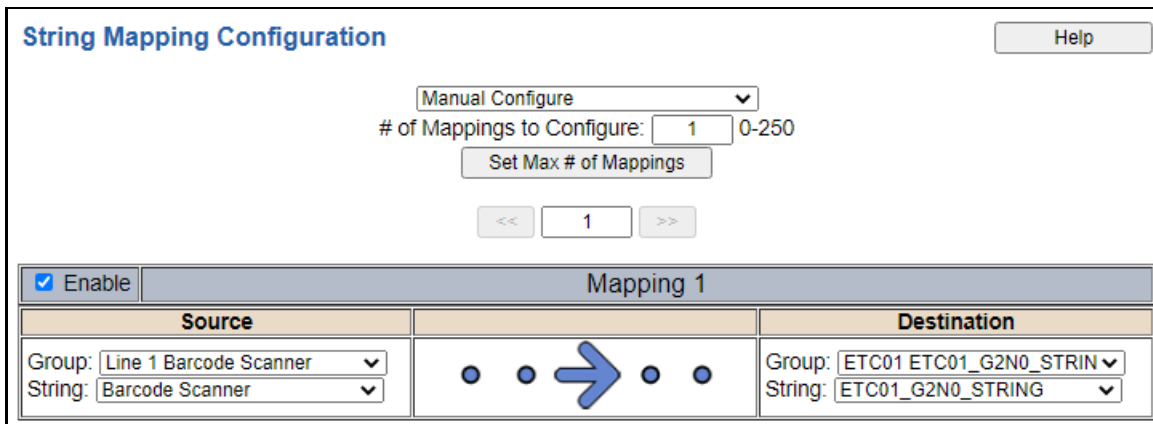

**String Mapping Configuration** Help

# of Mappings to Configure:  0-250

Set Max # of Mappings

<<  >>

| Mapping 1  |           |  |
|--|-----------|--|
| Source   |           | Destination  |
| Group: <input type="text" value="Line 1 Barcode Scanner"/> | ● ● → ● ● | Group: <input type="text" value="ETC01_ETC01_G2N0_STRIN"/> |
| String: <input type="text" value="Barcode Scanner"/>       |           | String: <input type="text" value="ETC01_G2N0_STRING"/>     |

To view the string mappings purely as text, click the **View as Text** button. For more details see the **View String Mapping as Text** section.

## Display String use case

Sending a message of “RTA,Support,Rocks” from an ASCII device to the RTA unit. The ASCII Parsing Configuration would look like my example below. There are more detailed examples of what all the fields represent in the ASCII Parsing section.

| ASCII Device 1 (Line1) |                |           |                       |                   |
|------------------------|----------------|-----------|-----------------------|-------------------|
| Max Number of Fields:  | 3              | 1-50      | Min Number of Fields: | 1                 |
| Parsing Delimiter:     |                | , 44 0x2c |                       |                   |
| Update Fields          |                |           |                       |                   |
| Field                  | Start Location | Length    | Data Type             | Internal Tag Name |
| 1:                     | 1              | 0         | String                | Header 1          |
| 2:                     | 1              | 0         | String                | Header 2          |
| 3:                     | 1              | 0         | String                | Header 3          |

The message is broken up into 3 “Groups” or Parsing fields.

**Display String** Edit Mapping  
View as Text

Select a Group  and a String  (3 bytes)

0000: 52 54 41 RTA

**Display String** Edit Mapping  
View as Text

Select a Group  and a String  (7 bytes)

0000: 53 75 70 70 6F 72 74 Support

**Display String** Edit Mapping  
View as Text

Select a Group  and a String  (5 bytes)

0000: 52 6F 63 68 73 Rocks

To view the Entire message, click on the Diagnostic drop down, select Diagnostics Info. Select ASCII, click view, select your Port. Whole data will be in the Last Message Sent Diagnostic box.

**Diagnostics** Last Message Sent (17 bytes)

0000: 52 54 41 2C 53 75 70 70 6F 72 74 2C 52 6F 63 68 RTA,Support,Rock

0016: 73 s

## Data and String Mapping – Auto-Configure

The Auto-Configure function looks at both protocols and will map the data between the two protocols as best as it can so that all data is mapped. Inputs of like data types will map to outputs of the other protocols like data types first. If a matching data type cannot be found, then the largest available data type will be used. Only when there is no other option is data truncated and mapped into a smaller data type.

If the Auto-Configure function does not map the data as you want or you want to add/modify the mappings, you may do so by going into Manual Configure mode.

The following are examples of the Auto-Configure function.

- 1) This example shows a common valid setup.



- a. Both Source values were able to be mapped to a corresponding Destination value.

- 2) This example shows how Auto-Configure will make its best guess.



- a. The 32-bit Float from the Source location could not find a matching Destination data-type. After all other like data types were mapped, the only data type available was the 2<sup>nd</sup> 32-bit Uint data type. Auto-Configure was completed even though the data in the Float will be truncated.

## Data Mapping – Explanation

Below are the different parts that can be modified to make up a data mapping.

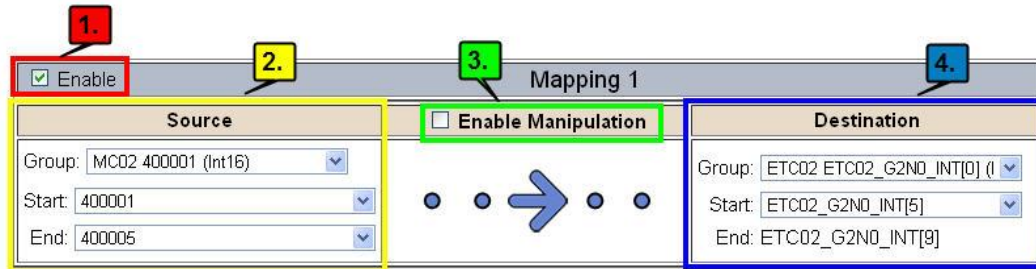

- 1) Enable (red box above): Check to enable mapping. If not checked, this mapping is skipped.
- 2) Source Field (yellow box above):
  - a) Group - Select the data group you set up in the protocol config to use for this mapping.
  - b) Start - This is the starting point for this mapping.
  - c) End - This is the final point to be included for this mapping.
- 3) Manipulation Area (green box above):
  - a) Enable the Data Manipulation. This can be enabled for any mapping.
  - b) Click **Add Math Operation** for each operation needed. Up to 3 are allowed unless you are using the Scale, Set Bit, or Invert Bit functions. If using Scale, Set Bit, or Invert Bit, then only 1 operation is allowed.
  - c) Select the Operation(s) to perform.
    - i) Math Operations are performed in the order they are selected.
    - ii) If more than one point is selected on the source, the Math Operations will be performed on every point.
  - d) Enter the value(s) for the operation.

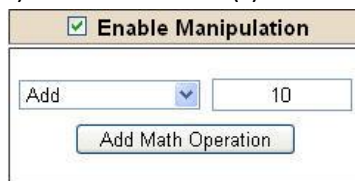

*Example of Add (similar for Subtract, Multiple, Divide, and MOD). This will add a value of 10 to the source field before it is written to the destination field.*

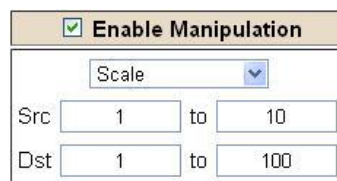

*Example of Scale. This will scale the source values from 1-10 into 1-100 for the destination.*

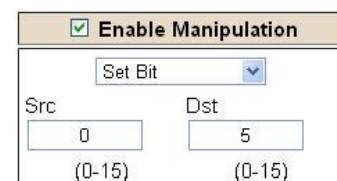

*Example of Set Bit (similar to Invert Bit). This will take the value of the 0<sup>th</sup> source bit and copy it into the value of the 5<sup>th</sup> destination bit.*

- 4) Destination Field (blue box above):
  - a) Group - Select the data group you set up in the protocol config to use for this mapping.
  - b) Start - This is the starting point for where the data is being stored.
  - c) End - The End point is derived from the length of the source and cannot be modified.



## Data Mapping – Adding Diagnostic Information

Data Mapping offers 5 different types of information in addition to any scan lines specified for each protocol.

**IMPORTANT NOTE:** Only add Diagnostic Information **AFTER** both sides of the gateway have been configured. If changes to either protocol are made after diagnostic information has been added to the mapping table, it is necessary to verify all mappings. Remapping may be necessary.

### 1) Temporary Ram (Int64)

- a) This offers five levels of 64bit Integer space to assist in multiple stages of math operations. For example, you may wish to scale and then add 5. You can set up a single translation to scale with the destination as the temporary ram. Then another translation to add 5 with the source as the temporary ram.
- b) The gateway will automatically convert the Source to fit the Destination, so there is no need for Int 8, 16, 32 since the 64 may be used for any case.

| <input checked="" type="checkbox"/> Enable Mapping 1               |   |  |
|--|---|--|
| Source   | <input checked="" type="checkbox"/> Enable Manipulation | Destination  |
| Group: Temporary Ram0 (Int64) <span style="float: right;">▼</span> | Scale <span style="float: right;">▼</span>              | Group: Temporary Ram0 (Int64) <span style="float: right;">▼</span> |
| Start: Ram0 <span style="float: right;">▼</span>                   | Src: 1 to 10  | Start: Ram1 <span style="float: right;">▼</span>                   |
| End: Ram0 <span style="float: right;">▼</span>                     | Dst: 1 to 100   | End: Ram1  |
| <input checked="" type="checkbox"/> Enable Mapping 2               |   |  |
| Source   | <input checked="" type="checkbox"/> Enable Manipulation | Destination  |
| Group: Temporary Ram0 (Int64) <span style="float: right;">▼</span> | Add <span style="float: right;">▼</span> 5              | Group: Temporary Ram0 (Int64) <span style="float: right;">▼</span> |
| Start: Ram1 <span style="float: right;">▼</span>                   | <input type="button" value="Add Math Operation"/>       | Start: Ram2 <span style="float: right;">▼</span>                   |
| End: Ram1 <span style="float: right;">▼</span>                     |   | End: Ram2  |

*In this example, Ram0 is scaled into Ram1. Ram1 is then increased by 5 and stored into Ram2. Ram0 and Ram2 could be considered a source or destination group.*

### 2) Temporary Ram (Double)

- a) This is like the Temporary Ram (Int 64), except manipulations will be conducted against the 64bit floating point to allow for large data.

### 3) Ticks Per Second

- a) The gateway operates at 200 ticks per second. This equates to one tick every 5ms. Thus, mapping this to a destination will give easy confirmation of data flow without involving one of the two protocols. If data stops on the destination end, then the RTA is offline.

| <input checked="" type="checkbox"/> Enable Mapping 1                     |  |  |
|--|--|--|
| Source   | <input type="checkbox"/> Enable Manipulation | Destination  |
| Group: Ticks Since Powerup (UInt32) <span style="float: right;">▼</span> |  | Group: BS01 AI1 (Float) <span style="float: right;">▼</span> |
| Start: Since Powerup <span style="float: right;">▼</span>                |  | Start: AI1 <span style="float: right;">▼</span>              |
| End: Since Powerup <span style="float: right;">▼</span>                  |  | End: AI1   |

#### 4) Heartbeat 100ms Update

- a) The Heartbeat 100ms Update variable can be used as a heartbeat that updates once every 100ms. The variable starts at 0 on gateway startup and increments by 1 every 100ms. This can be mapped into a destination on one of the available protocols to monitor the gateways connection status. If the value stops updating every 100ms the gateway is offline.

| Mapping 1   |   |  |
|---|---|--|
| Source  | <input type="checkbox"/> Enable Manipulation                                      | Destination  |
| Group: Heartbeat 100ms Update (Uir) ▾<br>Start: 100ms Update ▾<br>End: 100ms Update ▾ |  | Group: ETC01 Heartbeat (Int32) ▾<br>Start: Heartbeat ▾<br>End: Heartbeat |

#### 5) Heartbeat 1000ms Update

- a) The Heartbeat 1000ms Update variable can be used as a heartbeat that updates once every 1000ms. The variable starts at 0 on gateway startup and increments by 1 every 1000ms. This can be mapped into a destination on one of the available protocols to monitor the gateways connection status. If the value stops updating every 1000ms the gateway is offline.

| Mapping 1  |  |  |
|--|--|--|
| Source   | <input type="checkbox"/> Enable Manipulation                                       | Destination  |
| Group: Heartbeat 1000ms Update (U) ▾<br>Start: 1000ms Update ▾<br>End: 1000ms Update ▾ |  | Group: ETC01 Heartbeat (Int32) ▾<br>Start: Heartbeat ▾<br>End: Heartbeat |

#### 6) XY\_NetBmpStat

- a) If a protocol is a Client/Master, there is a Network Bitmap Status that is provided on the Diagnostics Info page under the Variables section.

|                          |            |
|--------------------------|------------|
| <b>Modbus RTU Master</b> |            |
| Device Status            |            |
| Connected and Running    |            |
| LED Status               |            |
| Connection Status:       | Connected  |
| Variables                |            |
| Network Bitmap Status:   | 0x0000001f |

- b) Since a Client/Master may be trying to communicate with multiple devices on the network, it may be beneficial to know if a Server/Slave device is down. By using this Network Bitmap Status, you can expose the connection statuses of individual devices. **Values shown are in HEX.**
- i) 0x00000002 shows that only device 2 is connected
  - ii) 0x00000003 shows that only devices 1 and 2 are connected
  - iii) 0x0000001f shows that all 5 devices are connected (shown in image above)

c) There are multiple ways to map the NetBmpStat.

**Option 1:** Map the whole 32bit value to a destination. Example below shows the NetBmpStat is going to an Analog BACnet object. Using a connection of 5 Modbus Slave devices AI1 will show a value of 31.0000. Open a calculator with programmer mode and type in 31, this will represent bits 0 – 4 are on. This mean all 5 devices are connected and running.

If using an AB PLC with a Tag defined as a Dint, then expand the tag within your RSlogix software to expose the bit level and define each bit as a description such as device1, device2, etc.

| Mapping 1   |   |   |
|---|---|---|
| Source  | Enable Manipulation   | Destination   |
| <input checked="" type="checkbox"/> Enable<br>Group: MM NetBmpStat (Uint32) ▾<br>Start: NetBmpStat ▾<br>End: NetBmpStat ▾ | <input type="checkbox"/> Enable Manipulation<br> | Group: BS01 AI1 (Float) ▾<br>Start: AI1 ▾<br>End: AI1 |

**Option 2:** You can extract individual bits from the NetBmpStat by using the Set Bit Manipulation and map those to a destination. You'll need a mapping for each device you want to monitor. Example below shows Modbus device 2 (out of 5) is being monitor to a BACnet Binary Object. You can define the object in the BACnet Name configuration.

| Mapping 1   |   |  |
|---|---|--|
| Source  | Enable Manipulation   | Destination  |
| <input checked="" type="checkbox"/> Enable<br>Group: MM NetBmpStat (Uint32) ▾<br>Start: NetBmpStat ▾<br>End: NetBmpStat ▾ | <input checked="" type="checkbox"/> Enable Manipulation<br>Set Bit ▾<br>Src: 1 (0-31)<br>Dst: 0 (0) | Group: BS01 BI1 (Bit1) ▾<br>Start: BI1 ▾<br>End: BI1 |

## 7) Status\_XY

- a) There are two Statuses provided, one for each protocol. This gives access to the overall status of that Protocol. Each Bit has its own meaning as follows:

**Common Status:** *0x000000FF (bit 0-7) 1<sup>st</sup> byte*

| Hex: | Bit Position: | Decimal: | Explanation:                         |
|------|---------------|----------|--------------------------------------|
| 0x00 | 0             | 0        | if we are a Slave/Server             |
| 0x01 | 0             | 1        | if we are a Master/Client            |
| 0x02 | 1             | 2        | connected (0 not connected)          |
| 0x04 | 2             | 4        | first time scan                      |
| 0x08 | 3             | 8        | idle (usually added to connected)    |
| 0x10 | 4             | 16       | running (usually added to connected) |
| 0x20 | 5             | 32       | bit not used                         |
| 0x40 | 6             | 64       | recoverable fault                    |
| 0x80 | 7             | 128      | nonrecoverable fault                 |

For this example, the ETC Status is mapped to a PLC tag called PLC\_Status

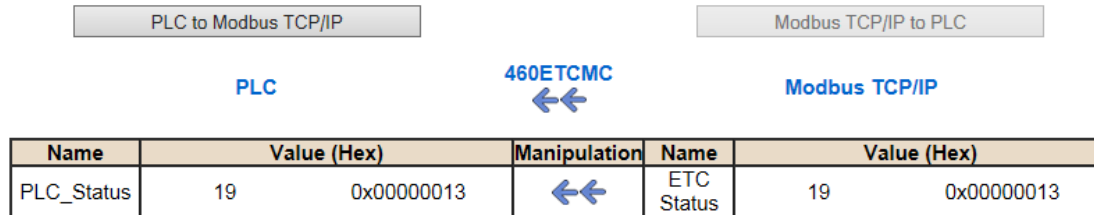

**Example:** ETC Status is 0x00000013 (19 decimal), here is the break down

| Hex    | Bit   | Decimal | Explanation                          |
|--------|-------|---------|--------------------------------------|
| 0x01   | 0(on) | 1       | if we are a Master/Client            |
| 0x02   | 1(on) | 2       | connected (0 not connected)          |
| 0x10   | 4(on) | 16      | running (usually added to connected) |
| Total: | 0x13  | 19      |                                      |

**External Faults:** *0x0000FF00 (bit 8-15) 2<sup>nd</sup> byte*

| Hex: | Bit Position: | Decimal: | Explanation:              |
|------|---------------|----------|---------------------------|
| 0x00 | 8             | 0        | local control             |
| 0x01 | 8             | 256      | remotely idle             |
| 0x02 | 9             | 512      | remotely faulted          |
| 0x04 | 10            | 1,024    | idle due to dependency    |
| 0x08 | 11            | 2,048    | faulted due to dependency |

**Recoverable Faults:** *0x00FF0000 (bit 16-23) 3<sup>rd</sup> byte*

| Hex: | Bit Position: | Decimal: | Explanation:                  |
|------|---------------|----------|-------------------------------|
| 0x01 | 16            | 65,536   | recoverable fault - timed out |
| 0x02 | 17            | 131,072  | recoverable fault - Slave err |

**Non-Recoverable Faults 0xFF000000 (bit 24-31) 4<sup>th</sup> byte**

| Hex: | Bit Position: | Decimal:    | Explanation:                             |
|------|---------------|-------------|--|
| 0x01 | 24            | 16,777,216  | nonrecoverable fault - task fatal err    |
| 0x02 | 25            | 33,554,432  | nonrecoverable fault - config missing    |
| 0x04 | 26            | 67,108,864  | nonrecoverable fault - bad hardware port |
| 0x08 | 27            | 134,217,728 | nonrecoverable fault - config err        |
| 0x10 | 28            | 268,435,456 | Configuration Mode                       |
| 0x20 | 29            | 536,870,912 | No Ethernet Cable Plugged In             |

For this example, the MC Status is mapped to a PLC tag called MC\_Status



**Example:** MC Status is 0x00010041 (65601 decimal), here is the break down, we know that bytes 1 and 3 are being used, so here is the break down,

**Common Status:**

| Hex: | Bit:  | Decimal: | Explanation:              |
|------|-------|----------|---------------------------|
| 0x01 | 0(on) | 1        | if we are a Master/Client |
| 0x40 | 6(on) | 64       | recoverable fault         |

**Recoverable Faults:**

| Hex: | Bit: | Decimal: | Explanation:              |
|------|------|----------|---------------------------|
| 0x01 | 16   | 65,536   | recoverable fault - timed |

Total:            0x010041            65,601

## String Mapping – Explanation

Below are the different parts that can be modified to make up a string mapping.

String data types can only be mapped to other string data types. There is no manipulation that can be done on the string.

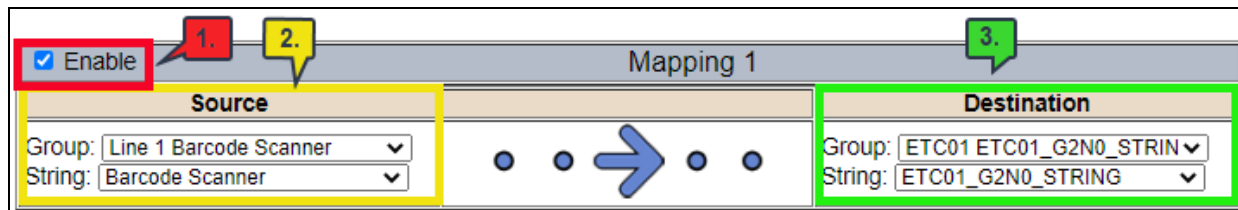

- 1) Enable (red box above): Check to enable mapping. If not checked, this mapping is skipped.
- 2) Source Field (yellow box above):
  - a) Group - Select the string data group you set up in the protocol config to use for this mapping.
  - b) String - This is the string used for this mapping.
- 3) Destination Field (green box above):
  - a) Group - Select the string data group you set up in the protocol config to use for this mapping.
  - b) String - This is the string where the data is being stored.

## Mapping – Auto-Configure Mode to Manual Configure Mode

To transition from Auto-Configure Mapping Mode to Manual Configure Mode, click the dropdown at the top of the Mapping Configuration page and select Manual Configure.

After you click this button, you will be prompted to confirm if this is really what you want to do.

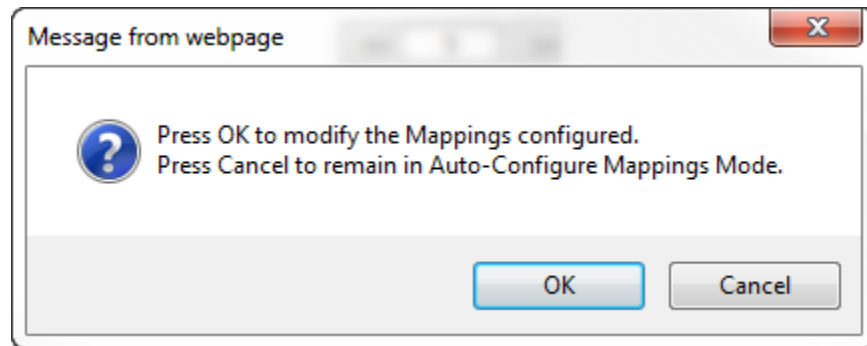

Click **OK** to proceed to Manual Configure Mode or click **Cancel** to remain in Auto-Configure Mappings Mode.

Once OK is clicked, there are 2 options on how to proceed from here.

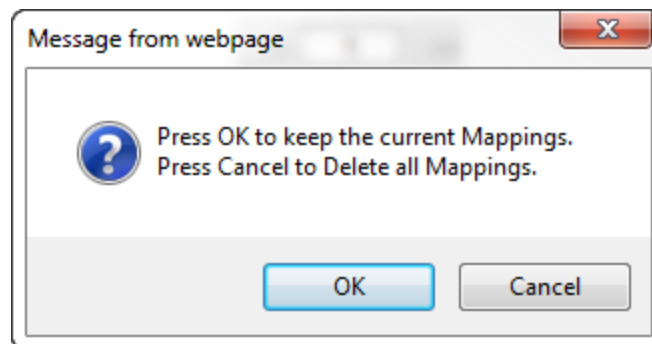

- 1) To keep the mappings that are already configured press **OK**.
  - a) You would want this option if you are adding additional mappings or you want to modify the mapping(s) that already exist.
- 2) To delete the mappings that are already there and start over press **Cancel**.

To modify the number of mappings, enter a number in the text field next to **# of Mappings to Configure** and click the **Set Max # of Mappings** button. You can always add more mappings if needed.

## Mapping – Manual Configure Mode to Auto-Configure Mode

To transition from Manual Configure Mode to Auto-Configure Mapping Mode, click the dropdown menu at the top of the Mapping Configuration page and select Auto-Configure Mappings.

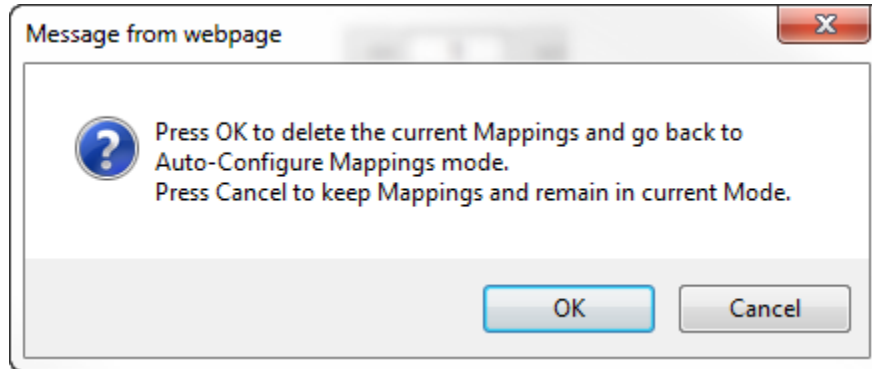

Click **OK** to proceed to delete all current mappings and go back to Auto-Configure Mappings Mode. Click **Cancel** to keep all mappings and remain in Manual Configure Mode.

**NOTE:** Once you revert to Auto-Configure Mapping Mode there is no way to recover the mappings you lost. Any mappings you previously have added will be deleted as well.



## View as Text

### Data Mapping

The View as Text page displays the point to point mapping(s) you set up in the Data Mapping section. This will also display any manipulation(s) that are configured.

Each line on this page will read as follows:

**Mapping number:** *source point* **Len:** *Number of points mapped* -> *manipulation (if blank then no manipulation)* -> *destination point*

If you are looking for a specific point to see if it is mapped, you can do a find in this text box for your point in question. Example: you defined 20 Registers starting at register 1 and want to see if 400011 is mapped. If it is not in this text box, then it is not mapped, and no data will be transferred.

This is the text display for the example shown under the *Data Mapping- Adding Diagnostic Information* section.

```
Data Mapping  
  
Mapping 1: Temporary Ram0 Len: 1 -> 1:10 Scale to 1:100 -> Temporary Ram1  
Mapping 2: Temporary Ram1 Len: 1 -> Add 5 -> Temporary Ram2
```

### String Mapping

The View as Text page displays the string mapping(s) you set up in the String Mapping section.

Each line on this page will read as follows:

**Mapping number:** *source point* -> **Copy** -> *destination point*

If you are looking for a specific point to see if it is mapped, you can do a find in this text box for your point in question. Example: you defined 20 String Tags in the PLC and want to see if “Test\_String” in the Logix PLC is mapped. If it is not in this text box, then it is not mapped, and no data will be transferred.

```
String Mapping  
  
Mapping 1: Logix Test_String -> Copy -> MC02 400001
```

## Base Triggering – Data Validation Triggering

With Base Triggering, you will be marking data as “Invalid” and force RTA Master/Controller/Client protocols to read all the read data points sources until ALL source protocols data is valid. You will be able to utilize the Handshake to map over to Technology Trigger and/or back over to your source protocol for reference.

### How does this work?

- 1) Map the Triggering Variable (Source) over to Trigger # (Dest).
- 2) If Trigger # value changes states mark all Trigger # protocols read data as “Invalid”.
- 3) Read all source read data points until ALL source read data is valid.
- 4) Handshake # value is set equal to Trigger # value.
- 5) Map Handshake # to reference data point.

**Note:** # is an internal reference to the Server/Slave number you are settings up. **ex.** RTA Server/Slave products can only be Trigger 1 and Handshake 1 since we are only 1 device. If RTA is a Master/Client, then you can have a Trigger# for each server/slave connected too.

### How do you set this up?

In this example I’m using a 460MCBS. My Building Automation System wants to verify that all data read from Modbus TCP/IP Server is valid.

- 1) Add an extra Analog Output for your Trigger. This tells the RTA to mark all data invalid.

**Write Data Groups (BACnet/IP to 460MCBS)**

| Data Group | Object Type                  | Starting Object | # of Objects |
|------------|------------------------------|-----------------|--------------|
| 1          | Analog Output (32 Bit Float) | 1               | 21           |
| 2          | Binary Output                | 1               | 0            |
| 3          | CharacterString Value        | 51              | 0            |

- a) You can define AI21 as your validation name in the Setup BACnet Names Configuration.

Setup BACnet Names, Units, and COV

|    |     |                         |       |          |          |
|----|-----|-------------------------|-------|----------|----------|
| 21 | G01 | Data Validation Trigger | Other | no-units | 1.000000 |
|----|-----|-------------------------|-------|----------|----------|

- 2) Add another Analog Input as reference for when data has been validated. When you write from AO21 to validate data, the RTA will reply to AI40 saying “validation complete”.

| Data Group | Object Type                 | Starting Object | # of Objects |
|------------|-----------------------------|-----------------|--------------|
| 1          | Analog Input (32 Bit Float) | 1               | 40           |
| 2          | Binary Input                | 1               | 0            |
| 3          | CharacterString Value       | 1               | 0            |

|    |     |                        |       |          |          |
|----|-----|------------------------|-------|----------|----------|
| 40 | G01 | Data Validation Result | Other | no-units | 1.000000 |
|----|-----|------------------------|-------|----------|----------|

- 3) Within the Data Mapping page manually add 2 additional mappings.
- 4) The first mapping is going to be the Data Validation Triggering. AO21 will write to the RTA, MC Trigger 1 will mark data invalid.

| Mapping 2   |   |  |
|---|---|--|
| Source  | <input type="checkbox"/> Enable Manipulation                                      | Destination  |
| Group: BS01 AO1 (Float)<br>Start: AO21<br>End: AO21 |  | Group: MC Trigger 0 (Uint16)<br>Start: Trigger 1<br>End: Trigger 1 |

- 5) The second mapping, the MC Handshake will increment that all data is validated and write to AI21 "all data is validated". The value of AI40 and AO21 should be the same.

| Mapping 3  |   |   |
|--|---|---|
| Source   | <input type="checkbox"/> Enable Manipulation                                      | Destination   |
| Group: MC Handshake 0 (Uint16)<br>Start: Handshake 1<br>End: Handshake 1 |  | Group: BS01 AI1 (Float)<br>Start: AI40<br>End: AI40 |

## Security Configuration

To setup security on the 460 gateway, navigate to **Other->Security Configuration**. You can configure Security for 3 administrators, 5 users, and 1 guest.

### THIS IS **NOT** A TOTAL SECURITY FEATURE

The security feature offers a way to password protect access to diagnostics and configuration on the network. The security feature does not protect against “Air Gap” threats. If the gateway can be physically accessed, security can be reset. All security can be disabled if physical contact can be made. From the login page, click the Reset Password button twice. You will be forced to do a hard reboot (power down) on the gateway within 15 minutes of clicking the button. This process should be used in the event a password is forgotten.

**Note:** Only Admins have configuration access to all web pages.

- 1) Log Out Timer: The system will automatically log inactive users off after this period of time.  
**NOTE:** A time of 0 means that the user will not be automatically logged off. Instead, they must manually click the **Logout** button.
- 2) Username: Enter a username, max of 32 characters.
- 3) Password: Enter a password for the username, max of 32 characters, case sensitive.
  - a. Re-enter the Password
- 4) E-mail: In case the password was forgotten, a user can have their password e-mailed to them if e-mail was configured.
- 5) Hint: A helpful reminder of what the password is.

**Security Configuration** Help

Log Out Timer:  0-15 min

**Admin Configuration**

| Admin | Username             | Password             | Re-enter Password    | Email          | Hint                 |
|-------|----------------------|----------------------|----------------------|----------------|----------------------|
| 1     | <input type="text"/> | <input type="text"/> | <input type="text"/> | Not Configured | <input type="text"/> |
| 2     | <input type="text"/> | <input type="text"/> | <input type="text"/> | Not Configured | <input type="text"/> |
| 3     | <input type="text"/> | <input type="text"/> | <input type="text"/> | Not Configured | <input type="text"/> |

**Admin Contact Information**

**User Configuration**

| User | Username             | Password             | Re-enter Password    | Email          | Hint                 |
|------|----------------------|----------------------|----------------------|----------------|----------------------|
| 1    | <input type="text"/> | <input type="text"/> | <input type="text"/> | Not Configured | <input type="text"/> |
| 2    | <input type="text"/> | <input type="text"/> | <input type="text"/> | Not Configured | <input type="text"/> |
| 3    | <input type="text"/> | <input type="text"/> | <input type="text"/> | Not Configured | <input type="text"/> |
| 4    | <input type="text"/> | <input type="text"/> | <input type="text"/> | Not Configured | <input type="text"/> |
| 5    | <input type="text"/> | <input type="text"/> | <input type="text"/> | Not Configured | <input type="text"/> |

## Security Configuration-Security Levels

Each webpage in the gateway can have a separate security level associated with it for each user.

Security Levels:

- 1) **Full Access:** Capability to view and configure a web page.
- 2) **View Access:** Capability to view a web page, but cannot configure parameters.
- 3) **No Access:** No capability of viewing the web page and page will be removed from Navigation.

| User 1: <input type="button" value="View"/> |  |
|---|--|
| User 1:                                     |  |
| User 2:                                     |  |
| User 3:                                     |  |
| User 4:                                     |  |
| User 5:                                     |  |
| Guest                                       |  |
| Web Page                                    | Security                                     |
| All Web Pages                               | No Access <input type="button" value="Set"/> |
| Web Page                                    | Security                                     |
| Main Page                                   | Full Access <input type="button" value="v"/> |
| Device Configuration                        | Full Access <input type="button" value="v"/> |
| Port Configuration                          | Full Access <input type="button" value="v"/> |
| BACnet/IP Server                            | Full Access <input type="button" value="v"/> |
| Modbus RTU Master                           | Full Access <input type="button" value="v"/> |
| View Mapping                                | Full Access <input type="button" value="v"/> |
| Mapping                                     | Full Access <input type="button" value="v"/> |
| Setup LED's                                 | Full Access <input type="button" value="v"/> |
| Diagnostic Info                             | Full Access <input type="button" value="v"/> |
| Logging                                     | Full Access <input type="button" value="v"/> |
| Display Data                                | Full Access <input type="button" value="v"/> |
| Export Configuration                        | Full Access <input type="button" value="v"/> |
| Import Configuration                        | Full Access <input type="button" value="v"/> |
| Save As Template                            | Full Access <input type="button" value="v"/> |
| Load From Template                          | Full Access <input type="button" value="v"/> |
| Utilities                                   | Full Access <input type="button" value="v"/> |
| Email Configuration                         | Full Access <input type="button" value="v"/> |
| Alarm Configuration                         | Full Access <input type="button" value="v"/> |
| String Mapping                              | Full Access <input type="button" value="v"/> |
| View String Mapping                         | Full Access <input type="button" value="v"/> |
| Display String                              | Full Access <input type="button" value="v"/> |

## Security - Log In

**Username:** Name of the user to login.

**Password:** Password of the user to login.

**Log In:** If login is successful, the user will be redirected to the Main Page.

**Send Password to Email:** Sends the specified User's Password to the email configured for that user.

**Display Hint:** Displays the hint specified for the User if one was set up.

**Reset Password:** This is used to reset security settings. Confirm reset password must be selected to confirm this action. Once confirmed, there is a 15 minute window to do a hard reset of the gateway by physically removing and restoring power from the gateway. Once power is restored, you may navigate to the IP address of the gateway as normal.

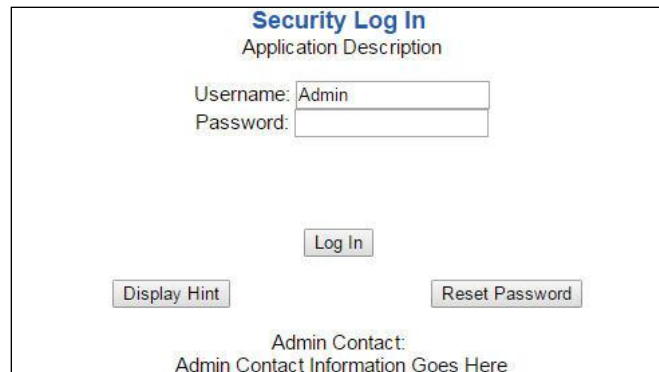

The screenshot shows a web interface titled "Security Log In" with the subtitle "Application Description". It contains a form with two input fields: "Username:" with the value "Admin" and "Password:". Below the form are three buttons: "Log In", "Display Hint", and "Reset Password". At the bottom, there is a label "Admin Contact:" followed by the text "Admin Contact Information Goes Here".

## Security - Log Out

Once a user is done with a session they may click **logout** at the top of any page. The user may also be logged out for inactivity based off of the Log Out Timer specified during the configuration.



The screenshot shows the header of the RTA web interface. On the left is the RTA logo. In the center, it says "Welcome Admin" followed by a "logout" link. On the right is the website URL "www.rtaautomation.com". Below this is a blue bar with "Real Time Automation, Inc." on the left and "MODE: RUNNING 460" on the right.

**Closing the browser is not sufficient to log out.**

## Email Configuration

To setup e-mails on the 460 gateway, navigate to **Other->Email Configuration**.

You can configure up to 10 email addresses.

- 1) SMTP Mail Username: The email address that the SMTP server has set up to use.
- 2) SMTP Mail Password: If authentication is required, enter the SMTP Server's password (Optional).
- 3) SMTP Server: Enter the Name of the SMTP Server or the IP Address of the Server.
- 4) From E-mail: Enter the e-mail that will show up as the sender.
- 5) To E-mail: Enter the e-mail that is to receive the e-mail.
- 6) E-mail Group: Choose a group for the user. This is used in other web pages.

Click the **Save Parameters** button to commit the changes and reboot the gateway.

**Email Configuration**

Number of Emails to Configure:  0-10

| User | SMTP Mail Username   | SMTP Mail Password   | SMTP Server          | From Email           | To Email             | Email Group |
|------|----------------------|----------------------|----------------------|----------------------|----------------------|-------------|
| 1    | <input type="text"/> | <input type="text"/> | <input type="text"/> | <input type="text"/> | <input type="text"/> | Group A ▼   |

## Alarm Configuration

To setup alarms on the 460 gateway, navigate to **Other->Alarm Configuration**.

- 1) Alarm Delay upon Powerup: At Powerup, the gateway will have values of '0' stored for all data. This may cause alarms to trigger before these values are updated by the mating protocols. Set this field to provide needed time to update fields before considering values for alarms.

**Alarm Configuration**
Help

Alarm Delay upon Powerup:  0-3600 s

# of Alarms to Configure:  0-100

<<  >>

| <input checked="" type="checkbox"/> Enable                    | Alarm 1                             |                                       |              |  |
|---|-------------------------------------|---------------------------------------|--------------|--|
| Data Point  | Set Error                           | Clear Error                           | Alarm Name   | Email                                    |
| Ticks Since Powerup (Uint32) <input type="button" value="v"/> | >= <input type="button" value="v"/> | None <input type="button" value="v"/> | Gateway_test | Group A <input type="button" value="v"/> |
| Ticks Since Powerup <input type="button" value="v"/>          | <input type="text" value="1000"/>   | <input type="text" value="0"/>        |              |  |

<<  >>

- 2) Enter the number of alarms to configure and click **Set Max # Alarms** to generate those lines.
- 3) In the Data Point Section:
  - a. Top dropdown: select the Data Group. This dropdown menu will contain all groups that go from the gateway to the network.
  - b. Lower dropdown: select the Data Point's Specific Point. This is used to select which point in the group will be monitored for alarms.
- 4) In the Set Error Section:
  - a. Select the Set Error Operation in the top dropdown menu. Available options are <, >, <=, >=, !=, ==, and Change of State (COS). This is the operation that will be used to compare the Data Point value against the Error Value to determine if the alarm needs to be set.
  - b. Select the Set Error Value. This value is used as: 'Data Point's Value' 'Operation' 'Value.' Ex: Ticks Since Powerup >= 1000. This will set the alarm after 1000 ticks have elapsed since the unit powered up.



- 5) In the Clear Error Section:
  - a. Select the Clear Error Operation. Available options are <, >, <=, >=, !=, ==, and Change of State (COS). This is the operation that will be used to compare the Data Point value against the Error Value to determine if the alarm needs to be cleared.
  - b. Select the Clear Error Value.  
-Ex: Ticks Since Powerup >= 5000. This will clear the alarm after 5000 ticks have elapsed since the unit powered up.
- 6) Enter an Alarm Name. This will make the alarm unique and will be available in the Alarm Status page as well as in the email generated by the alarm.
- 7) Select an email to associate this alarm with. When an alarm is set, it sends an email. When an alarm is cleared, it will also send an email.

Click the **Save Parameters** button to commit the changes to memory and reboot the gateway.

## Diagnostics – Alarm Status

Alarm Status will only display under the Diagnostic menu tab if at least 1 Alarm is enabled.

- 1) # Alarms Enabled: This is a count of enabled alarms.
- 2) # Alarms Active: This is how many alarms are presently active (set).
- 3) Last Active Alarm: This is the last alarm that the gateway detected.
- 4) **Clear # of Times Active:** This will reset all alarms ‘# of Times Active’ to 0.
- 5) Alarm #: The reference number to the given alarm on the alarm setup page.
- 6) Name: The name of the alarm.
- 7) Status: The current status of the alarm, either OK or ALARM.
- 8) # of Times Active: This count represents the number of times this alarm has become active. If an alarm is triggered, this count will increment.

**Alarm Status**

# Alarms Enabled: 1  
 # Alarms Active: 0  
 Last Active Alarm:

---

| Alarm# | Name          | Status | # of Times Active |
|--------|---------------|--------|-------------------|
| 1      | Alarm Example | OK     | 0                 |

## Alarms – Active

While one or more alarms are active, every page will display ‘Alarms Active’ at the top of the page. This will no longer be displayed if all active alarms have been cleared.

www.rtaautomation.com

Real Time Automation, Inc.
Alarms Active
MODE: RUNNING

460

When an alarm is activated, the following will occur:

- 1) A one-time notification will be sent out to the email associated with the alarm.
- 2) For duplicate emails to occur, the alarm must be cleared and then become active again.
- 3) # Alarms Active and # of Times Active will be incremented.
- 4) Status of the Individual Alarm will be set to *Alarm*.
- 5) *Last Active Alarm* field will be populated with details on what triggered the alarm.

**Alarm Status**

# Alarms Enabled: 1  
 # Alarms Active: 1  
 Last Active Alarm: Alarm 1 is Set. Actual: 0 < Limit: 20

---

| Alarm# | Name          | Status | # of Times Active |
|--------|---------------|--------|-------------------|
| 1      | Alarm Example | Alarm  | 1                 |

## Alarms – Clear

When an alarm is cleared, the following will occur:

- 1) A one-time notification will be sent to the email associated with the alarm.
  - a. For duplicate emails to occur, the alarm must become active and then be cleared again.
- 2) Total # *Alarms Active* will decrement. *Last Active Alarm* will not be changed.
- 3) Status of the Individual Alarm will be reset to *OK*.

## Change of State (COS) Configuration

To access the configuration files in the 460 gateway, navigate to dropdown **Other->COS Configuration**. The gateway, by default only writes when data has changed. The gateway also waits to write any data to the destination until the source protocol is successfully connected.

**Default values should fit most applications. Change these values with caution as they affect performance.**

- 1) **Stale Data Timer:** If the data has not changed within the time allocated in this Stale Data Timer, the data will be marked as stale within the gateway and will force a write request to occur. This timer is to be used to force cyclic updates in the gateway, since data will only be written if it has changed by default. There is a separate timer per data mapping.  
**Gateway behavior:**
  - If time = 0s => (DEFAULT) The gateway will write out new values on a Change of State basis.
  - If time > 0s => The gateway will write out new values whenever the timer expires to force cyclic updates (write every x seconds).
- 2) **Production Inhibit Timer:** Amount of time after a Change of State write request has occurred before allowing a new Change of State to be written. This is to be used to prevent jitter. Default value is 0ms. This timer takes priority over the Stale Data Timer. There is a separate timer per data mapping. This timer is active only after the first write goes out and the first COS event occurs.
- 3) **Writes Before Reads:** If multiple writes are queued, execute # of Writes Before Reads before the next read occurs. Default is 10 and should fit most applications.  
**Warning:** A value of 0 here may starve reads if a lot of writes are queued. This may be useful in applications where a burst of writes may occur and you want to guarantee they all go out before the next set of reads begin.
- 4) **Reads Before Writes:** If multiple writes are queued, the # of Writes Before Reads will occur before starting the # of Reads Before Writes. Once the # of Reads Before Writes has occurred, the counter for both reads and write will be reset. Default is 1 and should fit most applications.
- 5) **Enable Data Integrity:** If enabled, do not execute any write requests to the destination until the source data point is connected and communicating. This prevents writes of 0 upon power up.
- 6) **Enable Mark Whole Entry New:** If Enabled, mark the entire scan line or data group new upon 1 data element within the scan line or data group to be new.

**Change of State Configuration**
Help

|                              |                                     |            |
|------------------------------|-------------------------------------|------------|
| Stale Data Timer:            | 0                                   | 0-3600 s   |
| Production Inhibit Timer:    | 0                                   | 0-60000 ms |
| Writes Before Reads:         | 10                                  | 0-255      |
| Reads Before Writes:         | 1                                   | 1-255      |
| Enable Data Integrity:       | <input checked="" type="checkbox"/> |            |
| Enable Mark Whole Entry New: | <input type="checkbox"/>            |            |

Click the **Save Parameters** button to commit the changes to memory and reboot the gateway.

## Diagnostics Info

The Diagnostics page is where you can view both protocols' diagnostics information, # of Data Mappings, # of String Mapping and # Alarm Mappings.

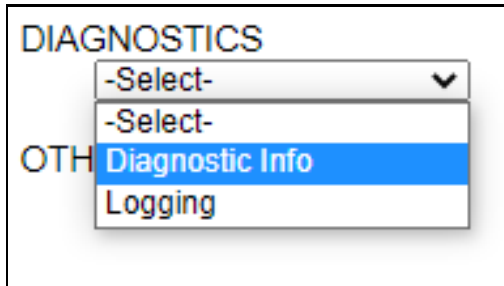

For protocol specific diagnostic information, refer to the next few pages.

## Diagnostics Mapping

This section displays the number of mappings that are enabled, Data Mapping and String Mapping will show the # of Errors and First Errors. Alarms will show # active and Last Alarm that was active.

### Common Errors:

- 1) Destination or Source Point does not exist
  - a) Solution: Re-map the mapping
- 2) Source or Destination Pointer too small
  - a) There is not enough space on either the Source, or the Destination for the data you want to copy. This is typically seen when the Destination is smaller than the amount of data being transferred to it.
- 3) Range Discard, Min or Max Value
  - a) The actual data value is outside of the defined range
- 4) Math Error
  - a) Operation value cannot be 0
- 5) Scaling Error
  - a) Source Min must be smaller than Source Max
  - b) Destination Min must be smaller than Destination Max

---

### Data Mapping

|              |        |
|--------------|--------|
| # Enabled:   | 5 of 5 |
| # of Errors: | 0      |
| First Error: |        |

---

### String Mapping

|              |        |
|--------------|--------|
| # Enabled:   | 2 of 2 |
| # of Errors: | 0      |
| First Error: |        |

---

### Alarms

|              |   |
|--------------|---|
| # Enabled:   | 3 |
| # Active:    | 0 |
| Last Active: |   |

---

**Note:** you can also view this information on the Main Page.

## Diagnostics – Modbus RTU Client

Select the Modbus RTU Client in the top dropdown menu on the Diagnostics Page to view a breakdown of the diagnostics and common strings that are displayed on the page. You may also view individual server counters by selecting the device in the *All Servers* dropdown and clicking **View**. Additional diagnostic information can be found by clicking the **Help** button.

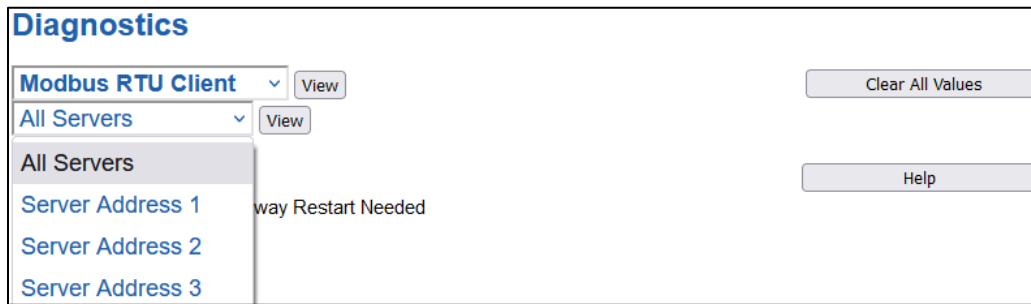

**NOTE:** This page will auto-refresh every five seconds with the latest data.

**Clear All Values** - This will only affect displayed values.

1) This will return all values displayed to zero and clear the Status Strings.

Example: If viewing Modbus RTU Client – Server Address 1, this will only clear the values for Server Address 1. This will reduce the *All Servers* values indirectly, otherwise select All Servers to clear all devices.

**Device Status** - This will only display when viewing *All Servers*.

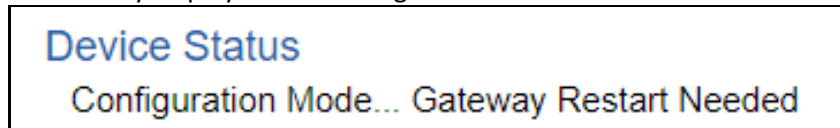

- 1) Connected and Running– the gateway is connected to all the Modbus RTU servers.
- 2) Error: Timeout – No Modbus RTU scan lines are configured under an enabled server.  
Or, one or more enabled Modbus RTU servers are missing.
  - a. Verify Modbus RTU device for server Address, 0 or 1 Base Addressing, ASCII Messaging, and Starting Addresses
  - b. Verify that Port Settings used match the Modbus server that the gateway is communicating with.
  - c. Verify wires for specific port settings.
- 3) Dependency Protocol Faulted – The dependent protocol is missing causing the communication to go inactive.
- 4) Unknown: First Scan Not Complete – Multiple scan lines are set up for the device and the gateway has not completed all the scan lines for the first time.
- 5) Fatal Error: Couldn't Open Hardware Port – The serial port selected on the Modbus RTU Client Configuration page is not configured.

Fatal Error: No Configuration – No Modbus RTU servers are enabled though a Serial Port is enabled.

**Diagnostics**

Modbus RTU Client

All Servers

**Device Status**  
Connected and Running

**LED Status**  
Connection Status: Connected

**Variables**

|                                 |            |
|---------------------------------|------------|
| Network Bitmap Status:          | 0x00000003 |
| FC01 Read Coil Status:          | 2488       |
| FC02 Read Input Status:         | 0          |
| FC03 Read Holding Registers:    | 0          |
| FC04 Read Input Registers:      | 0          |
| FC05 Force Single Coil:         | 0          |
| FC06 Preset Single Register:    | 0          |
| FC15 Force Multiple Coils:      | 0          |
| FC16 Preset Multiple Registers: | 0          |
| Successful Responses Received:  | 2113       |
| Error Responses Received:       | 0          |
| Timeouts:                       | 374        |

**Status Strings**  
Last Error Code:

**Diagnostics**

Modbus RTU Client

Server Address 1

**LED Status**  
Connection Status: Connected

**Variables**

|                                 |            |
|---------------------------------|------------|
| Network Bitmap Status:          | 0x00000003 |
| FC01 Read Coil Status:          | 1350       |
| FC02 Read Input Status:         | 0          |
| FC03 Read Holding Registers:    | 0          |
| FC04 Read Input Registers:      | 0          |
| FC05 Force Single Coil:         | 0          |
| FC06 Preset Single Register:    | 0          |
| FC15 Force Multiple Coils:      | 0          |
| FC16 Preset Multiple Registers: | 0          |
| Successful Responses Received:  | 1163       |
| Error Responses Received:       | 0          |
| Timeouts:                       | 187        |

**Status Strings**  
Last Error Code:

**LED Status** - This is the Status for *All Servers* or the specific server selected.

|  |
|--|
| <b>LED Status</b>  |
| Connection Status: <span style="font-size: 24pt; color: orange;">Configuration Mode</span> |

- 1) Solid Green (Connected) – The gateway is connected to all the Modbus RTU servers that are configured and enabled.
- 2) Flashing Green (Not Connected) – No Modbus RTU servers are enabled/configured.
  - a) Verify Modbus RTU settings and ensure that the *Enable* checkbox is checked for the appropriate server(s).
- 3) Flashing Red (Connection Timeout) - The gateway cannot open a connection to one or more of the enabled Modbus RTU devices.
  - a) Verify Modbus RTU device for server Address, 0 or 1 Base Addressing, ASCII Messaging, and Starting Addresses
  - b) Verify port settings used match the Modbus server that the gateway is communicating with.
  - c) Verify wires for specific port settings.
- 4) Flashing Red (Empty Scan List) - One or more enabled Modbus servers have no scan lines configured.
- 5) Flashing Red (Communication not attempted yet) – (Specific server only) No reads are configured and data needed for writes isn't valid yet.
- 6) Flashing Red (Dependency Error) - The dependent protocol is missing causing the communication to go to inactive.
  - a) The other protocol must be *Connected*.
- 7) Solid Red (Fatal Error) – The serial port selected on the Modbus RTU Client Configuration page is not configured.
  - a) Verify that Modbus RTU has an enabled Port selected. If needed, configure port settings.

**Variables** - These are the values for *All Servers* or the specific server selected.

#### Variables

|                                      |            |
|--------------------------------------|------------|
| Network Bitmap Status:               | 0x00000000 |
| FC01 Read Coil Status:               | 0          |
| FC02 Read Input Status:              | 0          |
| FC03 Read Holding Registers:         | 0          |
| FC04 Read Input Registers:           | 0          |
| FC05 Force Single Coil:              | 0          |
| FC06 Preset Single Register:         | 0          |
| FC15 Force Multiple Coils:           | 0          |
| FC16 Preset Multiple Registers:      | 0          |
| Successful Responses Received:       | 0          |
| Error Responses Received:            | 0          |
| Timeouts:                            | 0          |
| Read Request to Response Time (ms):  | 0          |
| Read Response to Request Time (ms):  | 0          |
| High Priority Read Loop Time (ms):   | 0          |
| Low Priority Read Loop Time (ms):    | 0          |
| Write Request to Response Time (ms): | 0          |
| Write Response to Request Time (ms): | 0          |
| Write Loop Time (ms):                | 0          |

#### Status Strings

Last Error Code:

- 1) Network Bitmap Status (Displayed in Hex):
  - a) -Each bit corresponds to a server. If the bit is set, the server is connected, otherwise the bit is 0.
  - b) -Bit 0 corresponds to Server 1 and Bit 4 is for Server 5 and so on.
- 2) FC01 Read Coil Status:
  - a) -Function Code 1: Number of read Coil Status requests sent
  - b) -Point Type Used: 0x Coil Status
  - c) -# of Points: Any
- 3) FC02 Read Input Status:
  - a) -Function Code 2: Number of read Input Status requests sent
  - b) -Point Type Used: 1x Input Status
  - c) -# of Points: Any
- 4) FC03 Read Holding Registers:
  - a) -Function Code 3: Number of read Holding Register requests sent
  - b) -Point Type Used: 4x Hold Reg
  - c) -# of Points: Any
- 5) FC04 Read Input Registers:
  - a) -Function Code 4: Number of read Input Register requests sent
  - b) -Point Type Used: 3x Input Reg
  - c) -# of Points: Any
- 6) FC05 Force Single Coil:
  - a) -Function Code 5: Number of write Coil Status requests sent
  - b) -Point Type Used: 0x Coil Status
  - c) -# of Points: 1
- 7) FC06 Preset Holding Register:



- a) -Function Code 6: Number of write Holding Register requests sent
- b) -Point Type Used: 4x Holding Reg
- c) -# of Points: 1
- 8) FC15 Force Multiple Coils:
  - a) -Function Code 15: Number of write Multiple Coil Status requests sent
  - b) -Point Type Used: 0x Coil Status
  - c) -# of Points: 2 or More OR Force Function Code 15/16 Enabled for # of Points of 1
- 9) FC16 Preset Multiple Registers:
  - a) -Function Code 16: Number of write Multiple Holding Register requests sent
  - b) -Point Type Used: 4x Holding Reg
  - c) -# of Points: 2 or More OR Force Function Code 15/16 Enabled for # of Points of 1
- 10) Successful Responses Received:
  - a) -Total number of Read and Write response messages received
  - b) -Note: Add up all the Function Code Variables and it should equal the number of Successful Responses Received
- 11) Error Responses Received:
  - a) -Total number of read and write error messages received
- 12) Timeouts:
  - a) -Total number of read and write response messages not received
- 13) Read Request to Response Time (ms):
  - a) -Number of milliseconds it took the Modbus RTU/ASCII device to reply to a request
- 14) Read Response to Request Time (ms):
  - a) -Number of milliseconds it took the gateway to execute the next request once the previous response has been received
- 15) High Priority Read Loop Time (ms):
  - a) -Number of milliseconds it took to execute all high priority read requests
- 16) Low Priority Read Loop Time (ms):
  - a) -Number of milliseconds it took to execute all low priority read requests
- 17) Write Request to Response Time (ms):
  - a) -Number of milliseconds it took the Modbus RTU/ASCII device to reply to a request
- 18) Write Response to Request Time (ms):
  - a) -Number of milliseconds it took the gateway to execute the next request once the previous response has been received
- 19) Write Loop Time (ms):
  - a) -Number of milliseconds it took to execute all write requests

**Status Strings** - These are the values for *All Servers*, or the specific server selected.

Last Error Code:

-Last read request error that the gateway received

**Error Code Breakdown:**

- 1) Error Code "code" - "Function" (N:"ServerAddr" A:"StartAddr" L:"Length")
  - a) Note: The Server Address will inform you of the device that had the error. The Starting Address and Length will inform you the specific scan line that had the error
- 2) Error Codes:
  - a) Error Code 1: Function Code received by the server is not valid

- b) Error Code 2: The Register/Status received by the server is not valid
  - c) Error Code 3: The value received by the server is not allowable
  - d) Error Code 4: An unrecoverable error occurred while the server was attempting to reply
  - e) Error Code 5: The server has accepted the request and is processing it, but a long duration of time will be required to reply
  - f) Error Code 6: The server is processing another message. The gateway will skip this message.
  - g) Error Code 7: The server has replied with a NAK. The server cannot perform the program function received in the query
- 3) Functions:
- a) Specific to the Function Code being used for the scan line
- 4) N (Server Address):
- a) Server address of the server that the error was received from
- 5) A (Starting Address):
- a) Starting address of the register/status that the error was received from
- 6) L (Length):
- a) Number of points of the register/status that the error was received from

Example:

|                                |   |
|--------------------------------|---|
| Successful Responses Received: | 0   |
| Error Responses Received:      | 29  |
| Timeouts:                      | 0   |
| <b>Status Strings</b>          |   |
| Last Error Code:               | Error Code 2 - FC15_WrMCIs (N:1 A:101 L:32) |

This Error Code indicates Code 2, the register was not valid. Other details are:

- Received the error with FC 15, trying to Force Multiple Coils (WrMCIs – Write Multiple Coils)
- N:1, from device 1, the first configured device
- A:101, Starting address of 101; aka: 000101 or 00101
- L:32, Multiple registers were trying to write 32 coils.

The Error Code indicates *not valid*, so the starting address was not found, or there were not 32 sequential coils to be written (101 through 132). To solve this, change the starting address, or reduce the # of Points configured.

## Diagnostics – S7 Client

Select the S7 Client in the dropdown menu on the Diagnostics Page to view breakdown of the diagnostics and common strings that are displayed on the page. You may also view individual server counters by selecting the device in the *All Servers* dropdown and clicking **View**. Additional diagnostic information can be found by clicking the **Help** button.

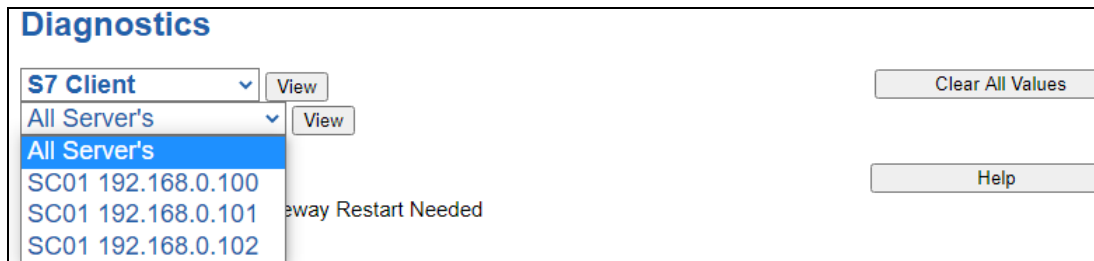

**NOTE:** This page will auto-refresh every five seconds with the latest data.

**Clear All Values** - This will only affect displayed values.

1) This will return all values displayed to zero and clear the Status Strings.

Example: If viewing S7 Client – SC02 10.1.100.17, this will only clear the values for that specific device. This will reduce the overall values indirectly, otherwise select All Servers to clear all devices.

**Device Status** - This will only display when viewing *All Servers*.



- 1) Connected – The gateway is connected to all the S7 Servers that are enabled and configured.
- 2) Not Connected
  - a) One or more enabled devices are missing
    - i) Verify S7 device for correct IP Address, Slot, Rack, or correct Starting Address
    - b) Fatal Error - No Configuration and/or Enabled and/or scan lines configured
    - c) Fatal Error – Configuration Invalid - One or more of the Servers configured is not on the same subnet as the gateway
- 3) Dependency Protocol Faulted – The dependent protocol is missing causing the communication to go to inactive.

|  |  |
|--|--|
| <p><b>Diagnostics</b></p> <p>S7 Client <input type="button" value="View"/></p> <p>All Server's <input type="button" value="View"/></p> <p>Clear All Values</p> <p>Device Status</p> <p>Not Connected</p> <p>LED Status</p> <p>Connection Status: Not Connected</p> <p>Variables</p> <p>Network Bitmap Status: 0x00000000</p> <p>Write Message Count: 0</p> <p>Read Message Count: 0</p> <p>Message Error Count: 0</p> <p>Timeouts Count: 0</p> <p>Help</p> | <p><b>Diagnostics</b></p> <p>S7 Client <input type="button" value="View"/></p> <p>SC01 0.0.0.0 <input type="button" value="View"/></p> <p>Clear All Values</p> <p>LED Status</p> <p>Connection Status: Invalid Configuration</p> <p>Variables</p> <p>Network Bitmap Status: 0x00000000</p> <p>Write Message Count: 0</p> <p>Read Message Count: 0</p> <p>Message Error Count: 0</p> <p>Timeouts Count: 0</p> <p>Help</p> |
|--|--|

**LED Status** - This is the Status for *All Servers* or the specific server selected.

|   |
|---|
| <p><b>LED Status</b></p> <p>Connection Status: Configuration Mode</p> |
|---|

- 1) Solid Green (Connected and Running):
  - a) The gateway is connected to all S7 servers that are configured and enabled
- 2) Flashing Green (Communication not attempted yet):
  - a) The gateway hasn't attempted to connect to the S7 server
- 3) Flashing Red (Not Connected):
  - a) One or more of the servers configured are missing (Nodes Missing)
  - b) The Dependency Protocol has Faulted
- 4) Flashing Red (Communication not attempted yet):
  - a) -No reads are configured, and data needed for writes isn't valid yet
- 5) Solid Red (Invalid Configuration):
  - a) No devices have been configured
  - b) No devices that have been configured are enabled
  - c) No devices that have been configured and enabled have scan lines configured
  - d) One or more of the servers configured is not on the same subnet as the gateway
- 6) Off:
  - a) No Power
  - b) No Ethernet cable connected

**Variables** - These are the values for *All Servers*, or the specific server selected.

|                                      |            |
|--------------------------------------|------------|
| <b>Variables</b>                     |            |
| Network Bitmap Status:               | 0x00000000 |
| Write Message Count:                 | 0          |
| Read Message Count:                  | 0          |
| Message Error Count:                 | 0          |
| Timeouts Count:                      | 0          |
| Read Request to Response Time (ms):  | 0          |
| Read Response to Request Time (ms):  | 0          |
| High Priority Read Loop Time (ms):   | 0          |
| Low Priority Read Loop Time (ms):    | 0          |
| Write Request to Response Time (ms): | 0          |
| Write Response to Request Time (ms): | 0          |
| Write Loop Time (ms):                | 0          |
| <b>Status Strings</b>                |            |
| Last Error Code:                     |            |

- 1) Network Bitmap Status (Displayed in Hex):
  - a) Each bit corresponds to a server. If the bit is set, the server is connected, otherwise the bit is 0.
  - b) Bit 0 corresponds to Server 1 and Bit 4 is for Server 5 and so on.
- 2) Write Message Count:
  - a) The number of write messages sent by the gateway
- 3) Read Message Count:
  - a) -The number of read messages sent by the gateway
- 4) Message Error Count:
  - a) The number of errors returned by the server in response to messages sent by the gateway
- 5) Timeouts:
  - a) Total number of Read and Write response messages not received by the gateway
- 6) Read Request to Response Time (ms):
  - a) -Number of milliseconds it took the S7 PLC to reply to a request
- 7) Read Response to Request Time (ms):
  - a) -Number of milliseconds it took the gateway to execute the next request once the previous response has been received
- 8) High Priority Read Loop Time (ms):
  - a) -Number of milliseconds it took to execute all high priority read requests
- 9) Low Priority Read Loop Time (ms):
  - a) -Number of milliseconds it took to execute all low priority read requests
- 10) Write Request to Response Time (ms):
  - a) -Number of milliseconds it took the S7 PLC to reply to a request
- 11) Write Response to Request Time (ms):
  - a) -Number of milliseconds it took the gateway to execute the next request once the previous response has been received
- 12) Write Loop Time (ms):
  - a) -Number of milliseconds it took to execute all write requests

**Status Strings** - These are the values for *All Servers*, or the specific server selected.

- 1) Last Error Code:
  - a) -Last read request error that the gateway received

**Error Code Breakdown:**

"Connection Error":

- Common Errors
- 0x00030000: Incorrect Rack or Slot number
- 0x00090000: Cannot connect to server

"Read/Write Error":

- Common Errors
- 0x00700000: Server doesn't support reading/writing that many points per scanline
- 0x00900000: Address out of range
- 0x00C00000: The Data Block (DB) received by the PLC is not valid.
- 0x01400000: Server security does not permit access with PUT/GET communication from remote partners. See Protection & Security settings in server to enable.
- 0x02300000: Read/Write timed out

## LED Configuration

To modify the behavior of the LEDs on the 460 gateway, navigate to **Other->Setup LEDs**.

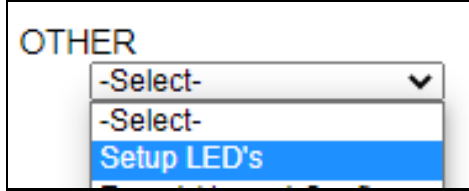

Each LED may be set to Disabled, Protocol 1, or Protocol 2. If either protocol is a master/client, you may set the LED to represent either all slaves/servers configured in the gateway or a slave/server device.

To select a slave/server device:

- 1) Select the protocol in the left dropdown menu.
- 2) Click **Save Parameters** to generate the second dropdown menu.
- 3) Select the individual slave/server in the right dropdown menu.

Click the **Save Parameters** button to commit the changes and reboot the gateway.

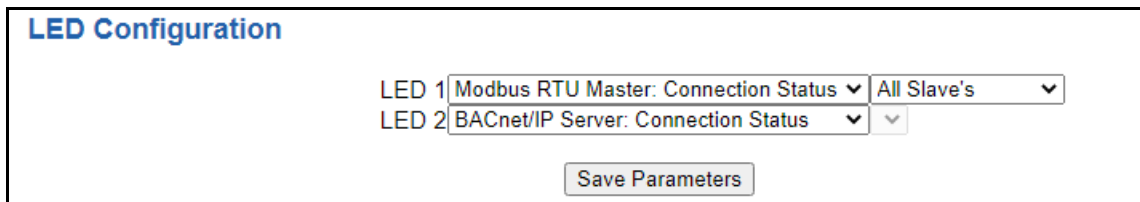
A screenshot of the 'LED Configuration' form. It features two rows of dropdown menus. The first row is labeled 'LED 1' and has two dropdowns: 'Modbus RTU Master: Connection Status' and 'All Slave's'. The second row is labeled 'LED 2' and has two dropdowns: 'BACnet/IP Server: Connection Status' and an empty dropdown. Below the dropdowns is a 'Save Parameters' button.

| LED   | Protocol                             | Device      |
|-------|--------------------------------------|-------------|
| LED 1 | Modbus RTU Master: Connection Status | All Slave's |
| LED 2 | BACnet/IP Server: Connection Status  |             |

Save Parameters

## Configuration Files

To access the configuration file in the 460 gateway, select the dropdown **Other->Export/Import Config**.

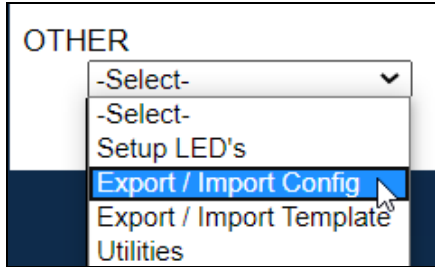

## Export Configuration



The Export Configuration allows you to save your configuration file for backup or to be imported into another gateway. This file is named *rta\_cfg.rtax* by default.

Upon clicking the **Save Configuration to File** button, you will be prompted to select a location to save the file. Different web browsers will yield different looks.



## Import Configuration

You can import a previously exported configuration file or a configuration file from another device into the 460 gateway, whenever it is in Configuration Mode.

Upon clicking the **Choose File** button, you will be prompted to select a location from which to load the saved file. Once the location is selected, you can choose the **Import Network Settings** checkbox if you want to load the network settings of the configuration file or just load the configuration without the network setting.

If you choose to Import Network Settings, this will override your current gateway's network setting with the settings in the configuration file. After you click on the Load Configuration button, a banner will display your gateway's new IP address.

**Network Settings have changed. Manually enter IP Address of X.X.X.X in the URL.**

If the configuration has successfully loaded, the gateway will indicate that it was successful, and a message will appear under the Load Configuration button indicating Restart Needed.

### Import Configuration

No file chosen

Import Network Settings

If it encountered an error while trying to load the saved configuration, the gateway will indicate the first error it found and a brief description about it under the Load Configuration button. Contact RTA Support with a screenshot of this error to further troubleshoot.



## Save and Replace Configuration Using SD Card

### Saving Configuration Using SD Card

This function saves the gateway's configuration automatically to an SD Card each time the gateway is rebooted via the **Restart Now** button on the web page. If this unit should fail in the future, the last configuration stored on the SD card and can be used for a new gateway to get the application back up and running quickly.

This SD Card replaces every configurable field in the gateway, **EXCEPT** for IP Address, Subnet Mask, and Default Gateway.

### Replacing Configuration Using SD Card

To replace a configuration in a gateway using the SD Card, a specific sequence of events must be followed for the replacement to happen correctly:

- 1) Extract SD Card from gateway you wish to copy the configuration from.
- 2) Power up the gateway you wish to copy the configuration to. **DO NOT INSERT SD CARD YET.**
- 3) Navigate to the webpage inside the unit.
- 4) Navigate to the dropdown **Other->Utilities**.
- 5) If you are not currently in *Mode: Configuration*, go into Configuration Mode by clicking the **Configuration Mode** button at the top left-hand side of the screen.
- 6) Press the **Revert to Manufacturing Defaults** button on the Utilities Page. The Configuration will **ONLY** be replaced by the SD Card if the gateway does not have a configuration already in it.
- 7) When the unit comes back in *Mode: Running*, insert the SD Card.
- 8) Do a hard power cycle to the unit by unplugging power. **DO NOT RESET POWER VIA WEB PAGES.**
  - a. It will take an additional 30 seconds for the unit to power up while it is transferring the configuration. During this time, the gateway cannot be accessed via the web page.
- 9) When the unit comes back up, the configuration should be exactly what was on the SD Card.

## Intelligent Reset Button

If the IP Address of the gateway is forgotten or is unknown, there is an easy way to recover the IP Address using a reset button on the hardware.



- 1) On the front of the gateway below the Power LED, there is a small pinhole. Using a paperclip, press the button through this pinhole and hold the button for at least 5 seconds.
- 2) After 5 seconds, the unit will acknowledge the command and LED 1 and LED 2 will start an alternate Blink Green quickly pattern.
- 3) Release the button and the gateway will reset both Ethernet ports to default IP settings (DHCP).

## Utilities

To access the Utilities page in the 460 gateway, navigate to **Other->Utilities**. The Utilities screen displays information about the gateway including Operation Time, File System Usage, Memory Usage, and Memory Block Usage.

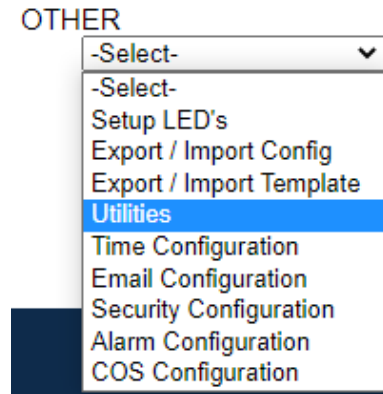

Here you can also:

- View the full revision of the software.
- View all the files stored in the Flash File System within the gateway.
- Identify your device by clicking the **Start Flashing LEDs** button. By clicking this button, the two diagnostic LEDs will flash red and green. Once you have identified which device you are working with, click the button again to put the LEDs back into running mode.
- Configure the size of the log through the Log Configuration.
- Bring the device back to its last power up settings.
- Bring the device back to its original manufacturing defaults.
- Remove the Configuration File and Flash Files within the gateway.

Revisions

Listing of Revisions

File List

File List

Identify Device

Start Flashing LED's

Set Up Log

Log Configuration

Revert To Last Powerup

Revert to Last Powerup

Revert All

Revert to Manufacturing Defaults

Reformat Flash

Reformat Flash